

DESCRIPTION

The EV4068-N-00A Evaluation Board is designed to demonstrate the capabilities of MP4068. The MP4068 is a highly integrated TRIAC dimmable LED driver with high power factor. It is specifically designed for low-line input (120VAC), no-isolated, TRIAC-dimmable LED lighting applications, especially for the low cost and small form factor applications.

The integrated 500V MOSFET ensures the system to withstand 500V surge test without MOV or TVS. Only a single winding inductor is required to realize the solution. It features MPS's proprietary hybrid operation mode which is designed to achieve good dimming performance.

The EV4068-N-00A is typically designed for driving an 8W TRIAC dimmable LED bulb with 50V_{TYP}, 160mA LED load from 108VAC to 132VAC, 60Hz.

The EV4068-N-00A has an excellent efficiency and meets IEC61547 surge immunity, IEC61000-3-2 Class C harmonics and EN55015 conducted EMI requirements. It has multi-protection function as over-voltage protection; output short-circuit protection, thermal shut down, etc.

ELECTRICAL SPECIFICATION

Parameter	Symbol	Value	Units
Input Voltage	V _{IN}	108 to 132	VAC
Output Voltage	V _{OUT}	50	V
LED Current	I _{LED}	160	mA
Output Power	P _{OUT}	8	W
Efficiency (full load)	η	>86	%
Power Factor	PF	>0.88	
THD	THD	<46	%

FEATURES

- Excellent TRIAC Dimming Performance
- Lowest Cost BOM
- Constant Current LED Driver
- Good LED Current Accuracy
- 500V MOSFET Integrated
- Internal HV Fast Start-Up
- Single Winding Inductor
- High Power Factor(>0.88)
- High Efficiency (>86%)
- LED Current Foldback at High Temperature
- Thermal Shutdown (Auto Restart with Hysteresis)
- VCC Under Voltage Lockout with Hysteresis (UVLO)
- Programmable Over Voltage Protection
- Output Short Circuit Protection
- Fit inside GU10 Bulb Enclosure

APPLICATIONS

- Solid State Lighting
- Industrial & Commercial Lighting
- Residential Lighting

All MPS parts are lead-free, halogen free, and adhere to the RoHS directive. For MPS green status, please visit MPS website under Quality Assurance.

"MPS" and "The Future of Analog IC Technology" are Registered Trademarks of Monolithic Power Systems, Inc.



Warning: Although this board is designed to satisfy safety requirements, the engineering prototype has not been agency approved. Therefore, all testing should be performed using an isolation transformer to provide the AC input to the prototype board.

EV4068-N-00A EVALUATION BOARD

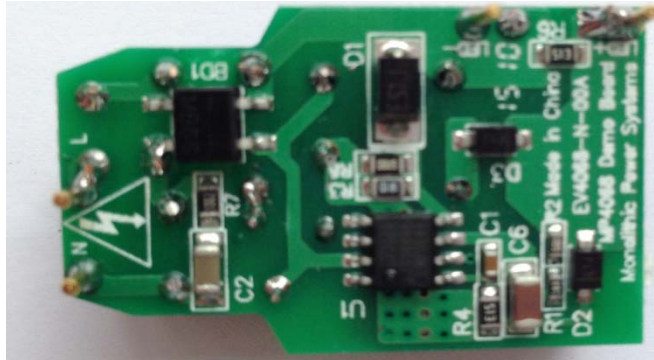

(L x W x H) 35mm x 23mm x 15mm

Board Number	MPS IC Number
EV4068-N-00A	MP4068GN

EVALUATION BOARD SCHEMATIC

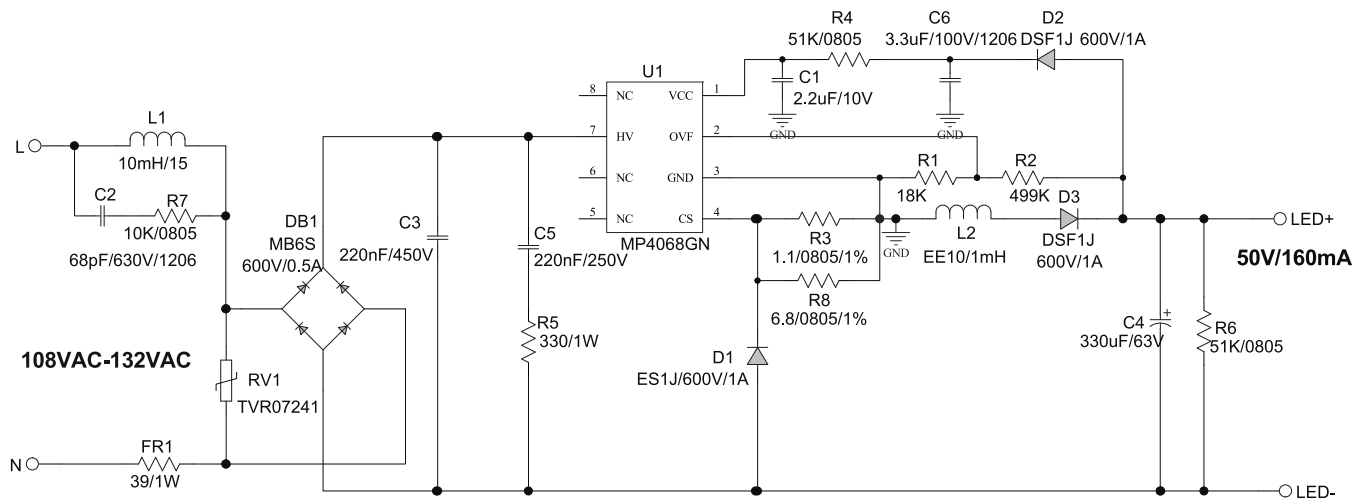

Figure 1—Schematic

PCB LAYOUT (SINGLE-SIDED)

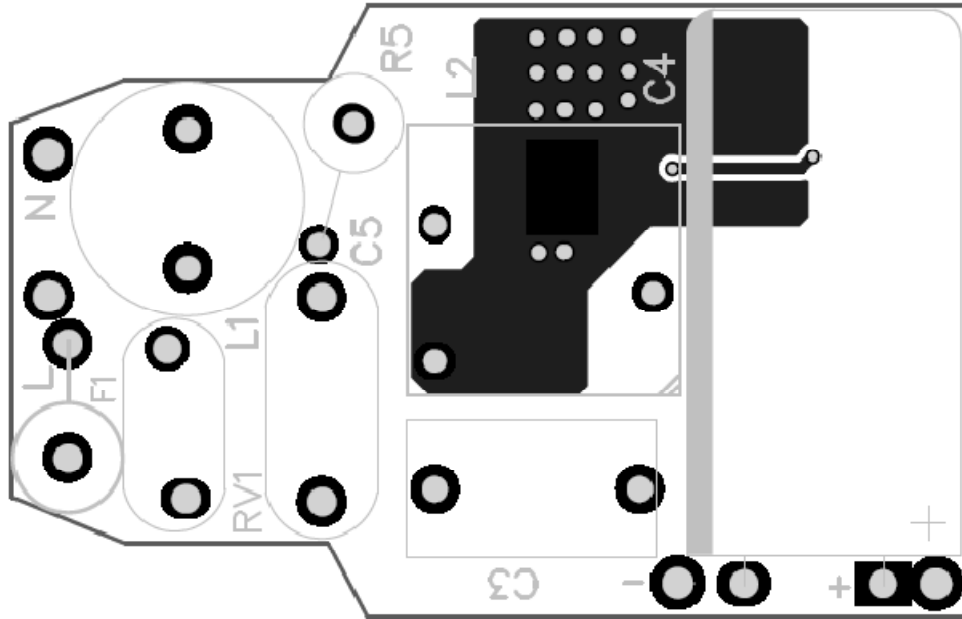

Figure 2—Top Layer

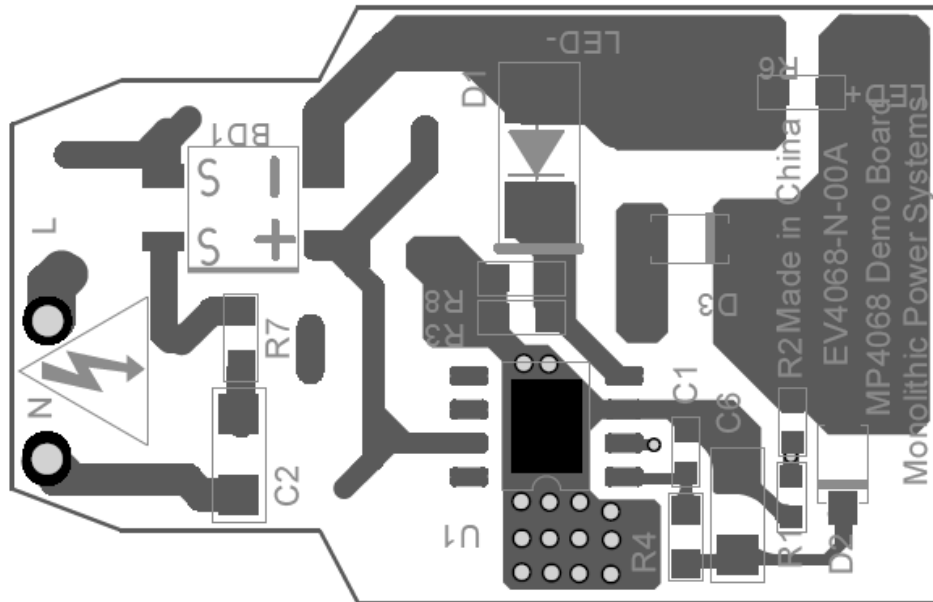

Figure 3—Bottom Layer

CIRCUIT DESCRIPTION

The EV4068-N-00A is configured in a single-stage Buck topology and gets a cost effective BOM. It also achieves high power factor and excellent TRIAC dimming performance.

FR1, RV1, L1, R7, C2, and BD1 compose the input stage. The fusible resistor FR1 fuses the AC input to protect for the component failure or some excessive short events, its resistance is also used as a passive damper of dimming. RV1 is used for surge test. L1, R7 and C2 associated with C3 form an EMI filter. The diode rectifier BD1 rectifies the input line voltage.

R5, C5 are used as a bleeder circuit which keeping the TRIAC current above the minimum holding current after TRIAC turns on.

R4, D2, C1 and C6 are used to supply the power for MP4068. At normal work, the power is charged by the internal high voltage regulator from HV pin. But in deep dimming condition, the

power may not be enough supplied only by the high voltage regulator, the diode D2 connected to output will help maintain the power supply voltage .

R1 and R2 are used to monitor the output OVP condition. The OVP voltage is set by the divider ratio of R1 and R2.

R3, R8 are sensing resistors for LED current control. The value of R3 and R8 set the output LED current.

Diode D1 is the Buck fly-wheel diode, the inductor L2 and the capacitor C4 are the output filter. The resistor R6 is placed as a dummy load to consume the output power in open load condition. The diode D3 is used to prevent the output current flowing back to IC when input Sine voltage drops lower than output voltage.

EV4068-N-00A BILL OF MATERIALS

Qty	Ref	Value	Description	Package	Manufacturer	Manufacture_P/N
1	C1	2.2 μ F/10V	Ceramic Cap, 10V, X7R	0603	muRata	GRM188R71A225KE15D
1	C2	68pF/630V	Ceramic Cap, 630V, C0G	1206	muRata	GRM31A7U2J680JW31D
1	C3	220nF/450V	CBB, 450V	DIP	Fara	C222S224K31C000
1	C4	330 μ F/63V	Electrolytic Capacitor, 63V	DIP	Jianghai	CD263-63V330
1	C5	220nF/250V	CBB, 250V	DIP	Fara	C222E224K30C000
1	C6	3.3 μ F/100V	Ceramic Cap, 100V, X7S	1206	TDK	C3216X7S2A335K
1	BD1	MB6S	Rectifier Bridge, 600V, 0.5A	SOIC-4	Taiwan Semiconductor	MB6S
1	D1	ES1J	Diode, 1A, 600V	SMA	Taiwan Semiconductor	ES1J
2	D2, D3	DSF1J	Diode, 1A, 600V	SOD-123FL	SXY	DSF1J
1	F1	39 Ω /1W	Fusible Res, 5%, 1W	DIP	Yageo	FKN1WSJT-52-39R
1	L1	10mH	Inductor	DIP	Hulsin	HDR0810-103K-N5
1	L2	1mH	Inductor, Φ 0.23mm, 180 turns	EE10	Emei	
1	R1	18k Ω	Thick Film Chip Res, 1%	0603	Yageo	RC0603FR-0718KL
1	R2	499k Ω	Thick Film Chip Res, 1%	0603	Yageo	RC0603FR-07499KL
1	R3	1.1 Ω	Thick Film Chip Res, 1%	0805	Yageo	RC0805FR-071R1L
1	R8	6.8 Ω	Thick Film Chip Res, 1%	0805	Yageo	RC0805FR-076R8L
2	R4, R6	51k Ω	Thick Film Chip Res, 5%	0805	Yageo	RC0805JR-0751KL
1	R5	330 Ω /1W	Metal Film Res, 1W, 5%	DIP	Any	Any
1	R7	10k Ω	Thick Film Chip Res, 5%	0805	Yageo	RC0805JR-0710KL
1	RV1	TVR07241	MOV	DIP	TKS	TVR07241
1	U1	MP4068GN	Triac-dimmable LED Lighting Controller	SOIC-8 EP	MPS	MP4068N-CU10 R4
4	L,N,LED+, LED	1.0 公针				1.0 公针

Winding Order

Winding No.	Tape Layer Number	Start & End	Magnet Wire Φ (mm)	Turns
	1			
N	3	8→2	0.23mm * 1	180

Electrical Specifications

Electrical Strength	60 second, 60Hz, from Winding to CORE.	1000VAC
Primary Inductance	Pins 2 - 8, all other windings open, measured at 100kHz, 0.1 VRMS	1mH±8%

Materials

Item	Description
1	Core: EE10, UI=2500±25%, AL=221.5H/N ² ±2% GAP, ACME P4 or equivalent
2	Bobbin: EE10, 4+4PIN RMMOVE PIN1,3,4,5,7
3	Wire: Φ 0.23mm, 2UEW, CLASS F or equivalent
4	Tape: 6.5mm(W)×0.06mm(TH)
5	Varnish: JOHN C. DOLPH CO, BC-346A or equivalent
6	Solder Bar: CHEN NAN: SN99.5/Cu0.5 or equivalent

EVB TEST RESULTS

Performance Data

Efficiency, PF and THD

f (Hz)	Vin(V)	Pin(W)	Vo(V)	Io (mA)	Po(W)	Efficiency (%)	PF	THD (%)
60	108	8.84	49.4	155	7.66	86.6	0.931	34.9
	120	9.31	49.5	163	8.07	86.7	0.908	40.2
	132	9.67	49.6	170	8.43	87.2	0.882	45.7

Dimming Compatibility (No Flicker with these 30 different Dimmers)

Dimmer No.	Manufacturer	Part No.	Power Stage	I _{max} (mA)	I _{min} (mA)
1	LUTRON	Q-600P-IV	600W Incandescent	150	9
2	LUTRON	CN-600P	600W	131	2
3	LUTRON	AY-600P	600W	131	2
4	LUTRON	SLV-600P	600W	132	2
5	LUTRON	LG-600P	600W	132	2
6	LUTRON	6B38-Q-600P	600W	133	2
7	LUTRON	GL-600H-DK	600W Incandescent	144	1
8	LEVITON	1G40O5	600W	133	0
9	LEVITON	1I20O5	600W	156	0
10	LEVITON	6633-P	600W	153	0
11	LUTRON	6B38-S-600P	600W	127	2
12	LUTRON	CT-600P	600W	127	3
13	LUTRON	6B38-S-603PG	600W	100	2
14	LUTRON	6B38-DV-600P	600W	126	3
15	LUTRON	DVCL-153P	600W	119	34
16	LUTRON	6B38-DVLV-600P	600W	129	4
17	LEVITON	1L10O5	600W	133	2
18	LUTRON	GLS01-C06570	600W	99	0
19	LUTRON	DV-600P-BR	600W Incandescent	127	3
20	LEVITON	6613-PL	600W Magnetic low voltage	151	1
21	LEVITON	C20-6684-IW	600W Incandescent	160	0
22	LUTRON	AY-600P-LA	600W Incandescent	133	3
23	LUTRON	TG-600PH-WH	600W	130	3
24	LUTRON	TG-603GH-WH	600W	93	3
25	LUTRON	S-600	600W	141	2
26	LUTRON	DVPDC-203P-WH	200W for Philips dimmable CFL	138	50
27	LUTRON	S-600P	600W	126	2
28	LUTRON	6B38-DV-603PG	600W	99	3
29	LUTRON	DNG-603PH-WH	400W	120	0
30	COOPER	6B28	600W	137	0

Electric Strength Test

Input and output was shorted respectively. 3750VAC/50Hz sine wave applied between input and output for 1min, and operation was verified.

Surge Test

Line to Line 500V surge testing was completed according to IEC61547.

Input voltage was set at 120VAC/60Hz. Output was loaded at full load and operation was verified following each surge event.

Surge Level (V)	Input Voltage (VAC)	Injection Location	Injection Phase (°)	Test Result (Pass/Fail)
500	120	L to N	90	Pass
-500	120	L to N	270	Pass

Thermal Test

Test without dimmer and with dimmer at 50% dimming on phase.

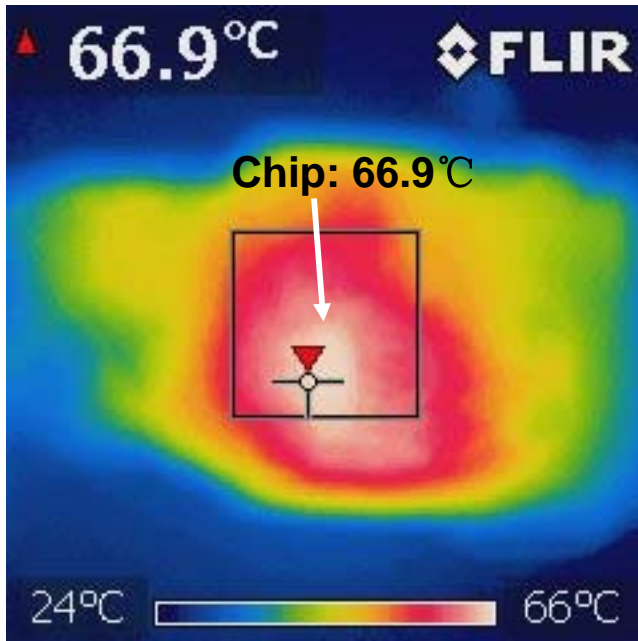

Without dimmer

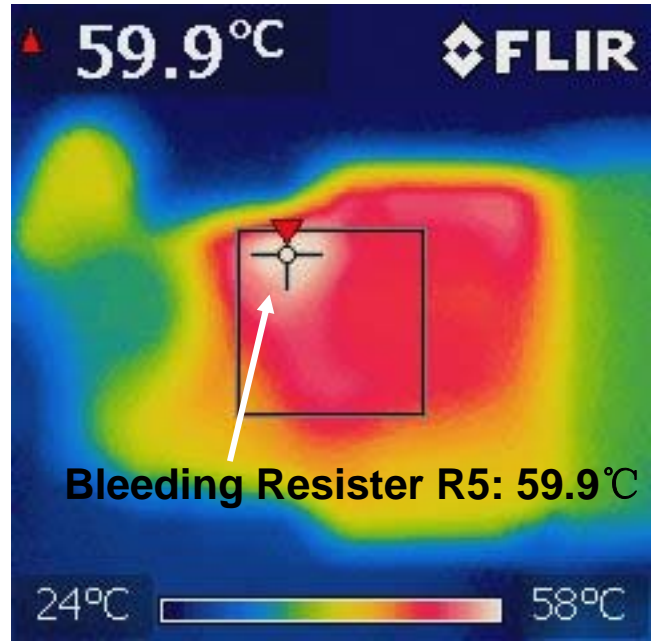

With dimmer at 50% dimming on phase

EVB TEST RESULTS

Performance waveforms are tested on the evaluation board.

$V_{IN}=120V_{AC}/60Hz$, 16 LEDs in series, $I_{LED}=160mA$, $V_{OUT}=50V$, $L=1mH$.

Line Regulation

$V_{IN}=(108-132)V_{AC}/60Hz$, Full Load

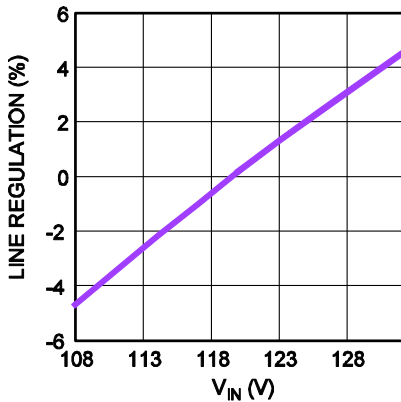

Load Regulation

$V_{IN}=(108-132)V_{AC}/60Hz$

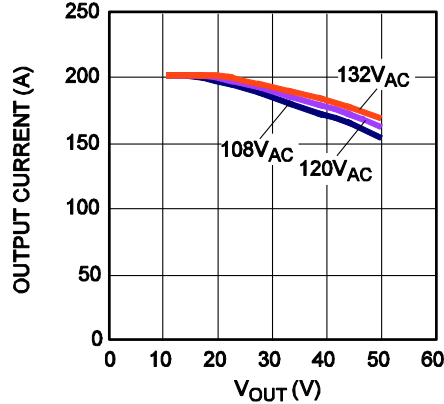

Efficiency

$V_{IN}=(108-132)V_{AC}/60Hz$, Full Load

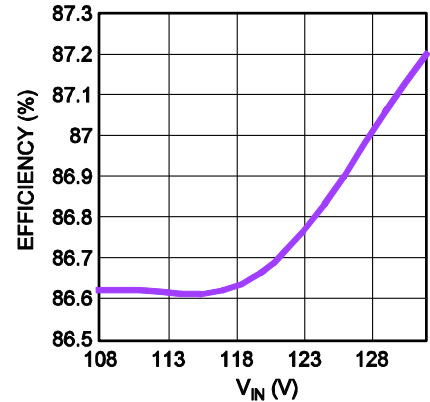

PF vs. V_{IN}

$V_{IN}=(108-132)V_{AC}/60Hz$, Full Load

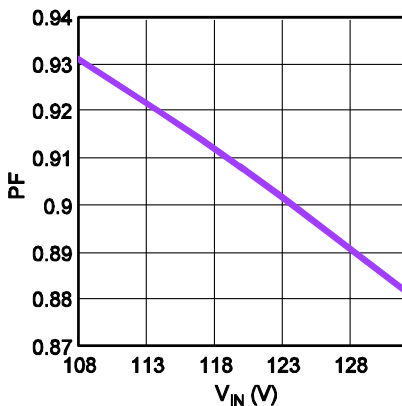

THD vs. V_{IN}

$V_{IN}=(108-132)V_{AC}/60Hz$, Full Load

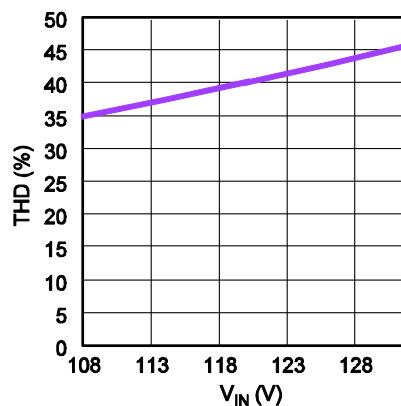

Dimming Curve

$V_{IN}=120V_{AC}/60Hz$, Full Load, with Different Dimmers

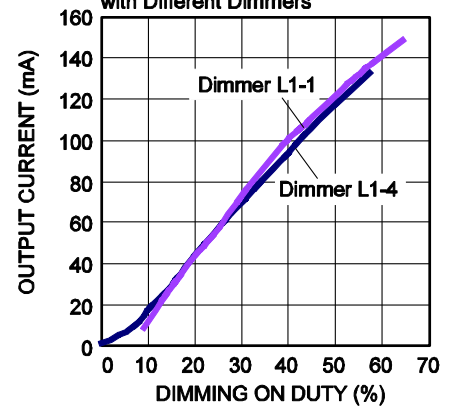

Conducted EMI, L-Line

$V_{IN}=115V_{AC}/60Hz$, RBW=9kHz, MT=20ms

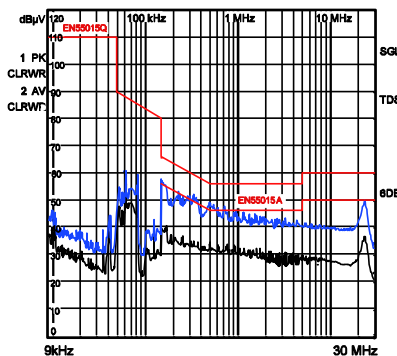

Conducted EMI, N-Line

$V_{IN}=115V_{AC}/60Hz$, RBW=9kHz, MT=20ms

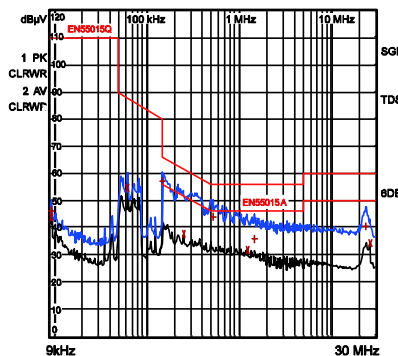

CDN Test

$V_{IN}=115V_{AC}/60Hz$, RBW=120kHz, MT=1ms

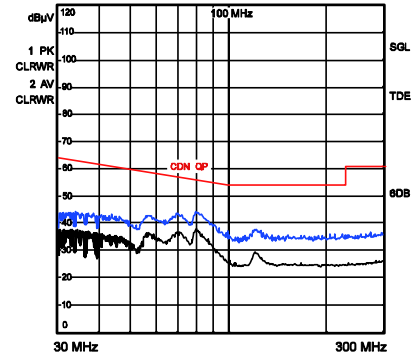

EVb TEST RESULTS *(continued)*

Performance waveforms are tested on the evaluation board.

$V_{IN}=120V_{AC}/60Hz$, 16 LEDs in series, $I_{LED}=160mA$, $V_{OUT}=50V$, $L=1mH$.

Steady State

$V_{IN}=120V_{AC}/60Hz$, Full Load

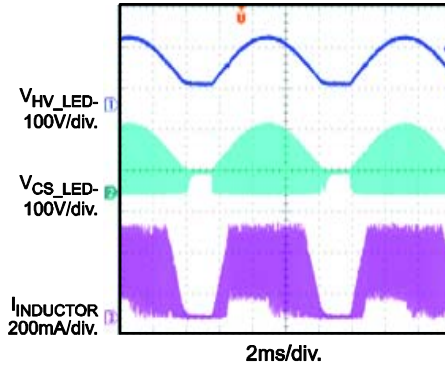

Steady State

$V_{IN}=120V_{AC}/60Hz$, Full Load

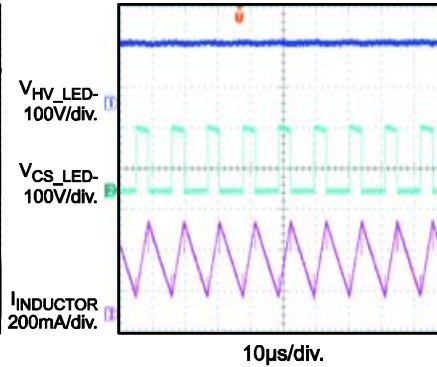

Steady State

$V_{IN}=120V_{AC}/60Hz$, Full Load

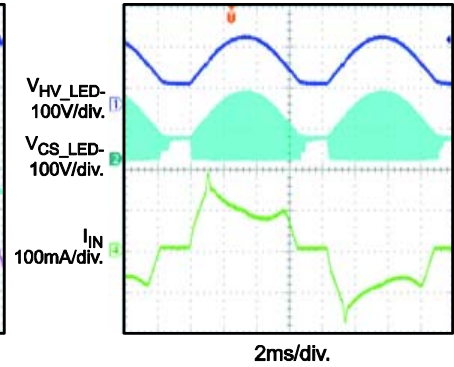

V_{IN} Start-Up

$V_{IN}=120V_{AC}/60Hz$, Full Load

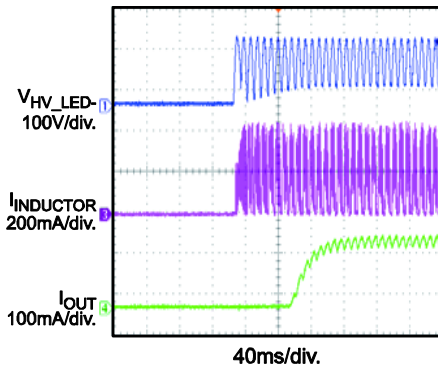

V_{IN} Shutdown

$V_{IN}=120V_{AC}/60Hz$, Full Load

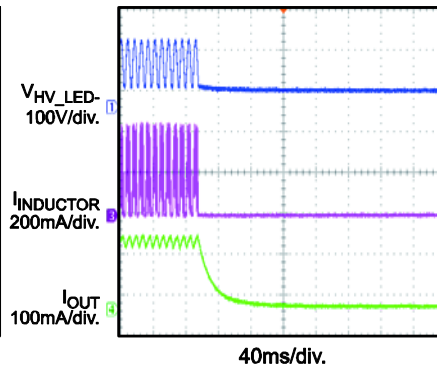

Dimming Performance

Max Dimming on Phase with Leading-Edge Dimmer

$V_{IN}=120V_{AC}/60Hz$

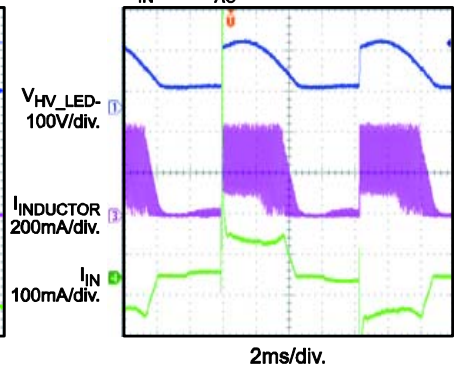

Dimming Performance

Min Dimming on Phase with Leading-Edge Dimmer

$V_{IN}=120V_{AC}/60Hz$

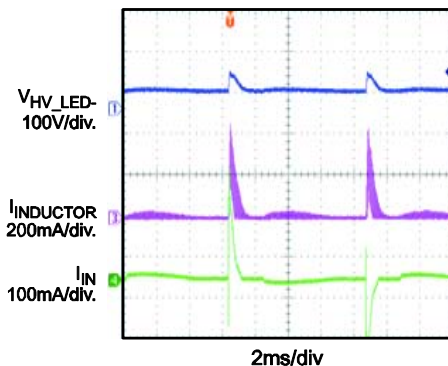

Dimming Performance

Max Dimming on Phase with Trailing-Edge Dimmer

$V_{IN}=120V_{AC}/60Hz$

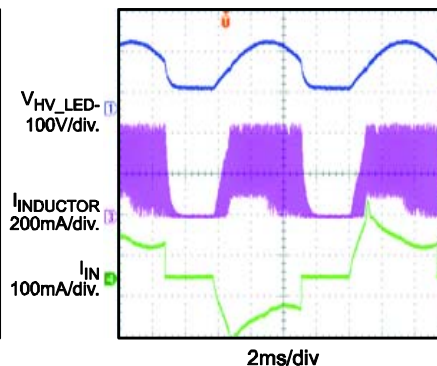

Dimming Performance

Min Dimming on Phase with Trailing-Edge Dimmer

$V_{IN}=120V_{AC}/60Hz$

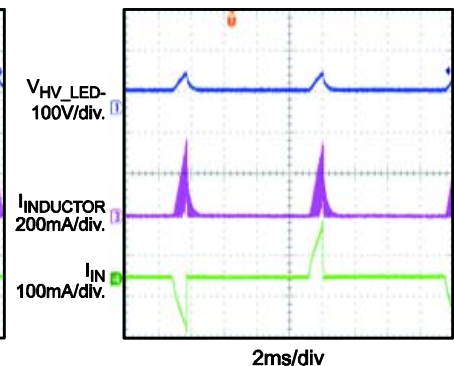

EVB TEST RESULTS *(continued)*

Performance waveforms are tested on the evaluation board.

$V_{IN}=120V_{AC}/60Hz$, 16 LEDs in series, $I_{LED}=160mA$, $V_{OUT}=50V$, $L=1mH$.

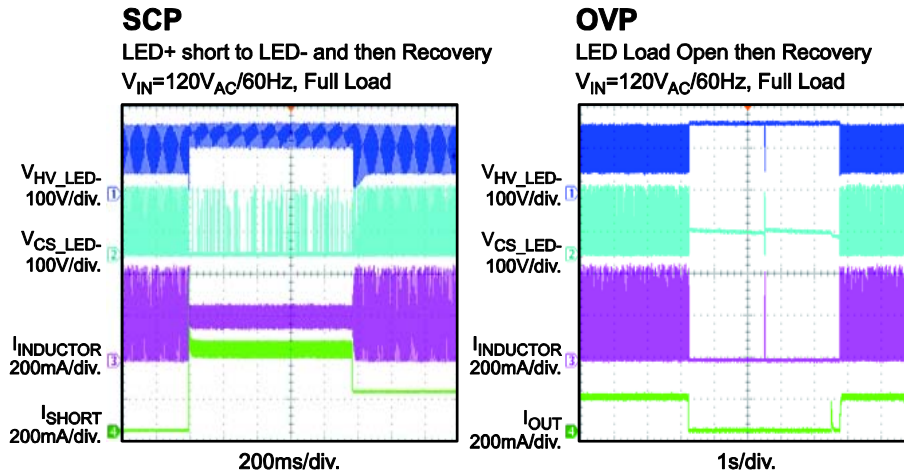

QUICK START GUIDE

1. Preset AC Power Supply to $108\text{VAC} \leq V_{\text{IN}} \leq 132\text{VAC}$.
2. Turn Power Supply off.
3. Connect the LED string between “LED+” (anode of LED string) and “LED-” (cathode of LED string).
4. Connect Power Supply terminals to AC V_{IN} terminals (“L” and “N”) as shown on the board.
5. Turn AC Power Supply on after making connections.

NOTICE: The information in this document is subject to change without notice. Users should warrant and guarantee that third party Intellectual Property rights are not infringed upon when integrating MPS products into any application. MPS will not assume any legal responsibility for any said applications.