



The Future of Analog IC Technology[®]

EV103-N-00A

**Offline Inductor-Less Controller
Evaluation Board**

PRELIMINARY SPECIFICATIONS SUBJECT TO CHANGE

Evaluation Board Report

5V 0.3W ACDC power supply

Design Specs	Value	Unit
Input Voltage	85-265	VAC
Output Voltage	5	VDC
Output Current	60	mA
Isolation	No	
MPS IC	MP103GN	
Application	<ul style="list-style-type: none"> • Wall Switches and Dimmers • Z-Wave Device and ZigBee Device for Home Automation • Standby Power for General Off-line Applications 	
Document Number	EBXXX	
Author	Application Engineering Department	
Date	Nov, 2014	
Revision	1.0	

Design Summary

EV103-N-00A evaluation board provides a reference design for a universal offline inductor-less power supply with 5V, 60mA output. It contains the complete specification of the power supply, a detailed circuit diagram, the entire bill of materials required to build the power supply, drawing of the power inductors and transformers, and test data of the most important performance.

DESCRIPTION

The MP103 is a good efficiency off-line linear regulator that directly steps down the AC line voltage to a regulated DC voltage. It provides a simple solution to provide a bias voltage to any ICs in the off-line application. Off-line linear regulator is designed to replace the conventional switching converter; it features no inductor required, low EMI noise and low BOM cost.

MP103 features as a controller that supports to drive low cost bipolar junction transistor. MP103 integrates an adaptive active VB-VOUT charging window method. The MP103 only works when it is necessary and only when the loss generated on the device is minimal. Such operation can achieve good efficiency and can help the system meet the new standby power specification.

MP103 offers rich protections, such as Thermal Shutdown (TSD), Over Temperature Protection (OTP), VB Over Voltage Protection (OVP), VB Short to GND Protection, Over Load Protection (OLP), Short Circuit Protection (SCP), MP103 is available in the SOIC8E package.

ELECTRICAL SPECIFICATION

Parameter	Symbol	Value	Units
Supply Voltage	V_{IN}	85~265	VAC
Output Voltage	V_{OUT}	5	V
Output Current	I_{OUT}	60	mA

FEATURES

- Universal AC Input (85Vac-305Vac)
- Inductor-Less
- Less than 100mW Standby Power
- Excellent EMI
- Low BOM Cost
- Smart Control to Maximum Efficiency
- Adjustable Output Voltage from 1.5V to 15V
- Good Line and Load Regulation
- Support to Drive BJT
- Short Circuit Protection
- External Programmable Over Temperature Protection (OTP)

All MPS parts are lead-free and adhere to the RoHS directive. For MPS green status, please visit MPS website under Quality Assurance. "MPS" and "The Future of Analog IC Technology" are Registered Trademarks of Monolithic Power Systems, Inc.

EV103-N-00A EVALUATION BOARD

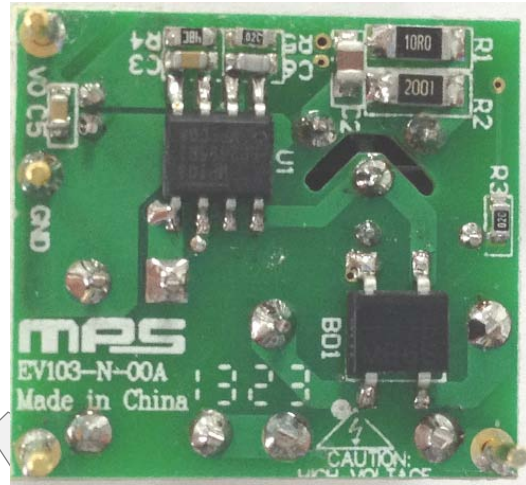

(L x W x H) 22mm x 24mm x 24mm

Board Number	MPS IC Number
EV103-N-00A	MP103GN

MPS CONFIDENTIAL
INTERNAL USE ONLY
DO NOT DISTRIBUTE

EVALUATION BOARD SCHEMATIC

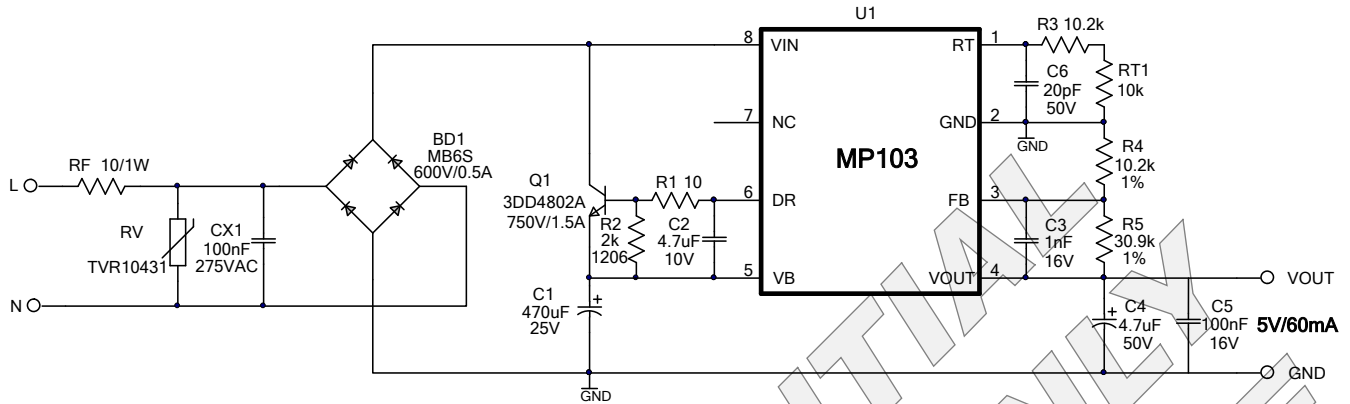

VOUT can be adjusted by choosing the value of R4 and R5, the relationship of them is:

$$V_{OUT} = 1.235V * (1 + R5/R4)$$

For example, to get 12V output voltage, we can choose, R4=10.2k, R5=90.9k.

The maximum output power (P_{OUT}) of MP103 Vs input voltage (V_{IN}) is depicted by following chart for 12V, 5V and 3.3V output applications respectively.

The test condition is: in open frame, ambient temperature is 25 °C, the temperature rise of MP103 is less than 60 °C on the test board.

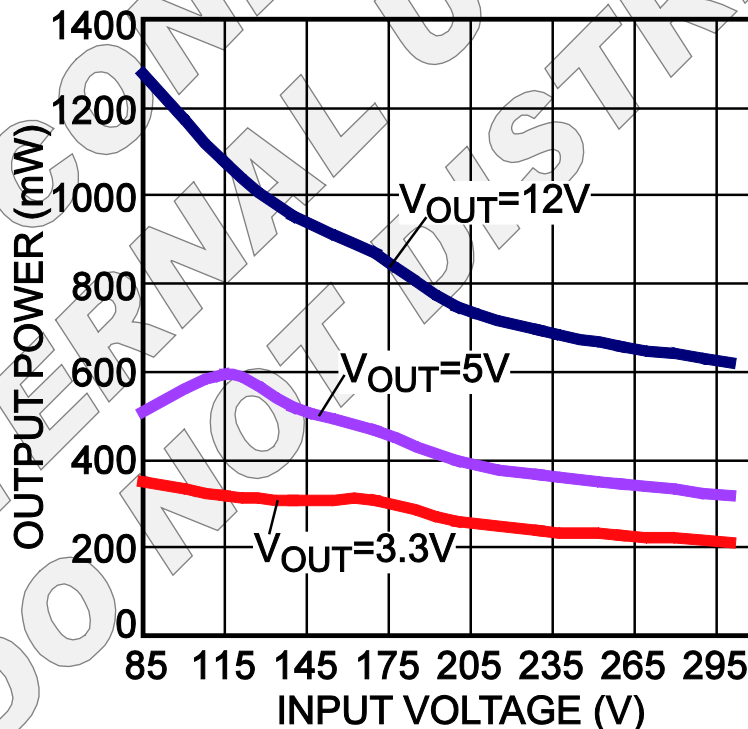

EV103-N-00A BILL OF MATERIAL

Qty	Ref	Value	Description	Package	Manufacture	Manufacturer_PN
1	BD1	MB6S	Diode;600V;0.5A;	SOIC-4	TaiWan Semiconductor	MB6S
1	C1	470 μ F	Electrolytic Capacitor; 25V;	DIP	Jianghai	CD287-25V470
1	C2	4.7 μ F	Ceramic Capacitor; 16V;	0805	Murata	GRM21BR61C475KA88L
1	C3	1nF	Ceramic Capacitor; 16V;X7R;	0603	Murata	GRM188R71C102KA01
1	C4	4.7 μ F	Electrolytic Capacitor; 50V;	DIP	Jianghai	CD287-50V4.7
1	C5	100nF	Ceramic Capacitor; 16V;X7R;	0603	LION	0603B104K160T
1	C6	20pF	Ceramic Capacitor; 50V;NPO;	0603	HHEC	C0603N200J050T
1	CX1	100nF	Film Capacitor; 275V;10%	DIP	Kaili	PX104K31C39L270D9R
1	Q1	3DD4802A	BJT,750V,1.5A;	TO-220F	Huawei	3DD4802A
1	R1	10 Ω	Film Resistor;5%;	1206	Yageo	RC1206JR-0710R
1	R2	2k Ω	Film Resistor;5%;	1206	Royalohm	1206F2001T5E
2	R3, R5	10.2k Ω	Film Resistor;1%;	0603	Yageo	RC0603FR-0710K2L
1	R4	30.9k Ω	Film Resistor;1%;	0603	Yageo	RC0603FR-0730K9L
1	RF	10 Ω	Resistor;5%;1W	DIP	Bangdayuan	10 Ohm/1W
1	RT1	10k Ω	NTC Resistor;5%;	DIP	Shiheng	MF52A103J3470F
1	RV	275Vac	TVR10431KSY, 430V(1mA);	DIP	TKS	TVR10431KSY
1	U1	MP103	Offline Regulator	SOIC8E	MPS	MP103GN

EVB TEST RESULTS

Performance waveforms are tested on the evaluation board.

$V_{OUT} = 5V$, $I_{OUT} = 60mA$, $T_A = 25^{\circ}C$, unless otherwise noted.

Efficiency vs. Load

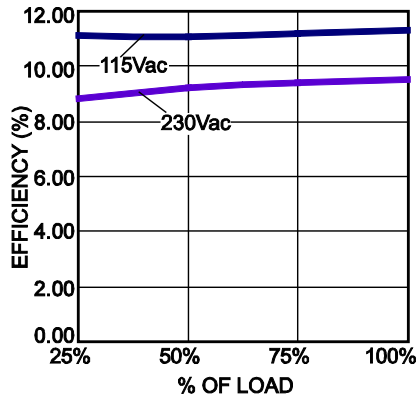

No Load Power vs. Input Voltage

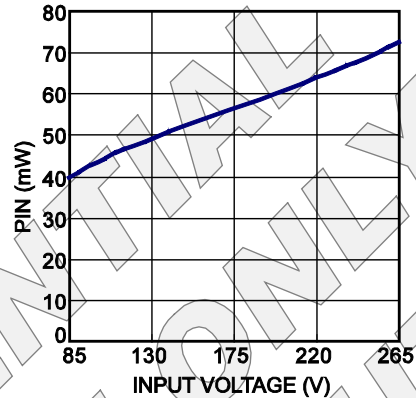

Input Power Startup
115Vac, 5V/60mA

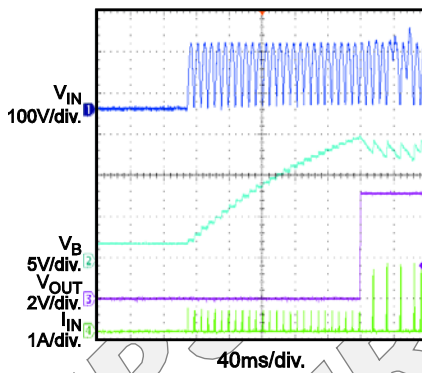

Input Power Startup
230Vac, 5V/60mA

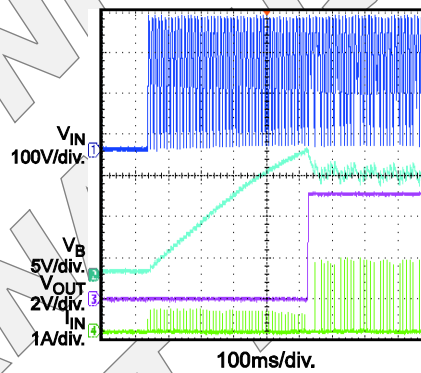

Steady State
115Vac, 5V/60mA

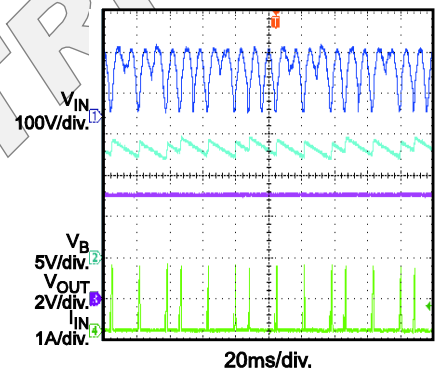

Steady State
230Vac, 5V/60mA

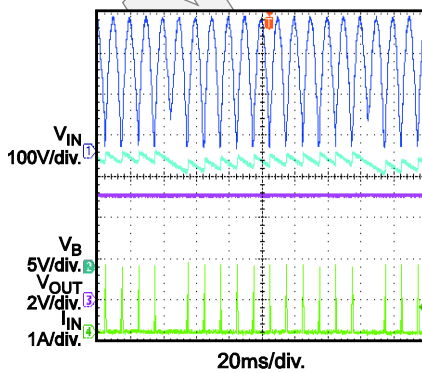

Input Power Shutdown
115Vac, 5V/60mA

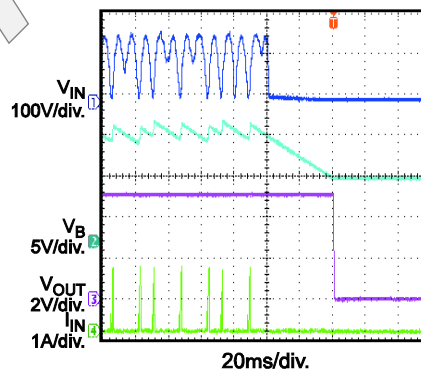

Input Power Shutdown
230Vac, 5V/60mA

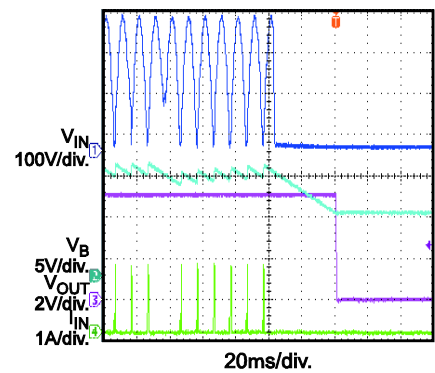

EVB TEST RESULTS *(continued)*

Performance waveforms are tested on the evaluation board.

 $V_{OUT} = 5V$, $I_{OUT} = 60mA$, $T_A = 25^\circ C$, unless otherwise noted.

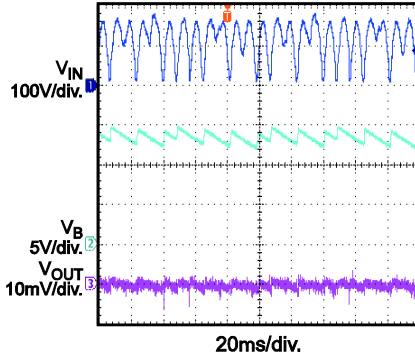
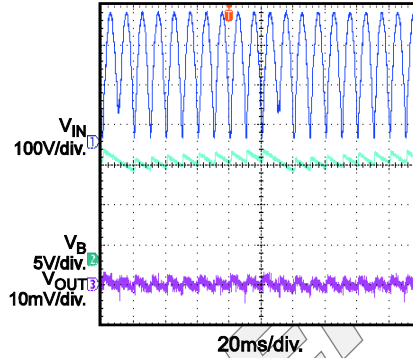
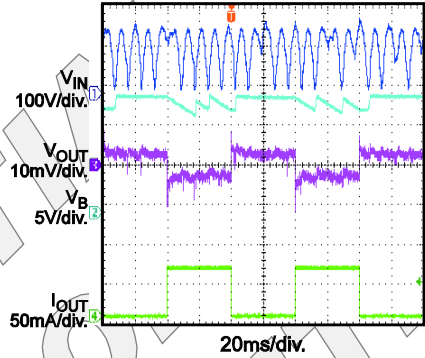
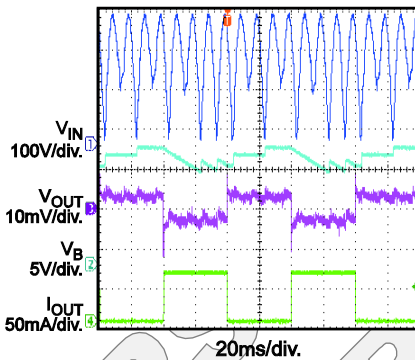
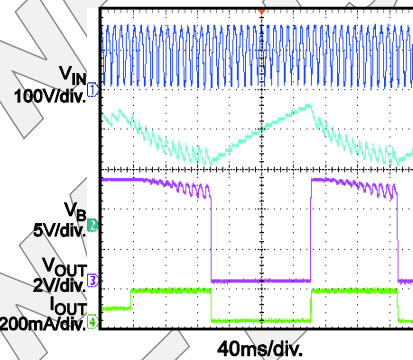
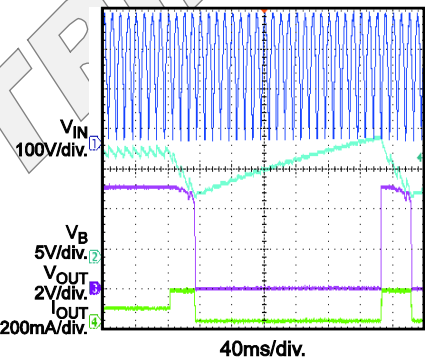
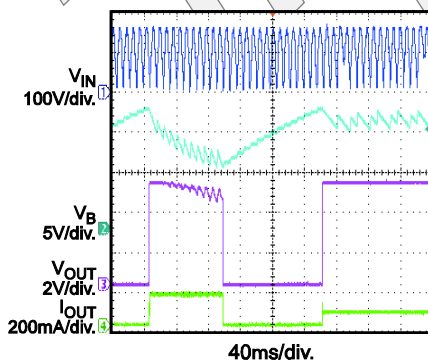
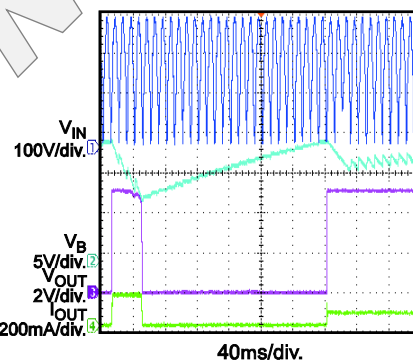
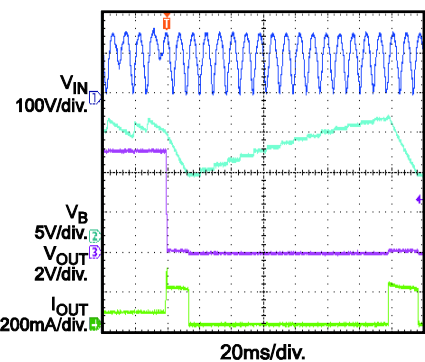
Output Ripple
 115Vac, 5V/60mA

Output Ripple
 230Vac, 5V/60mA

Load Transient
 115Vac, 5V, 0 to 60mA

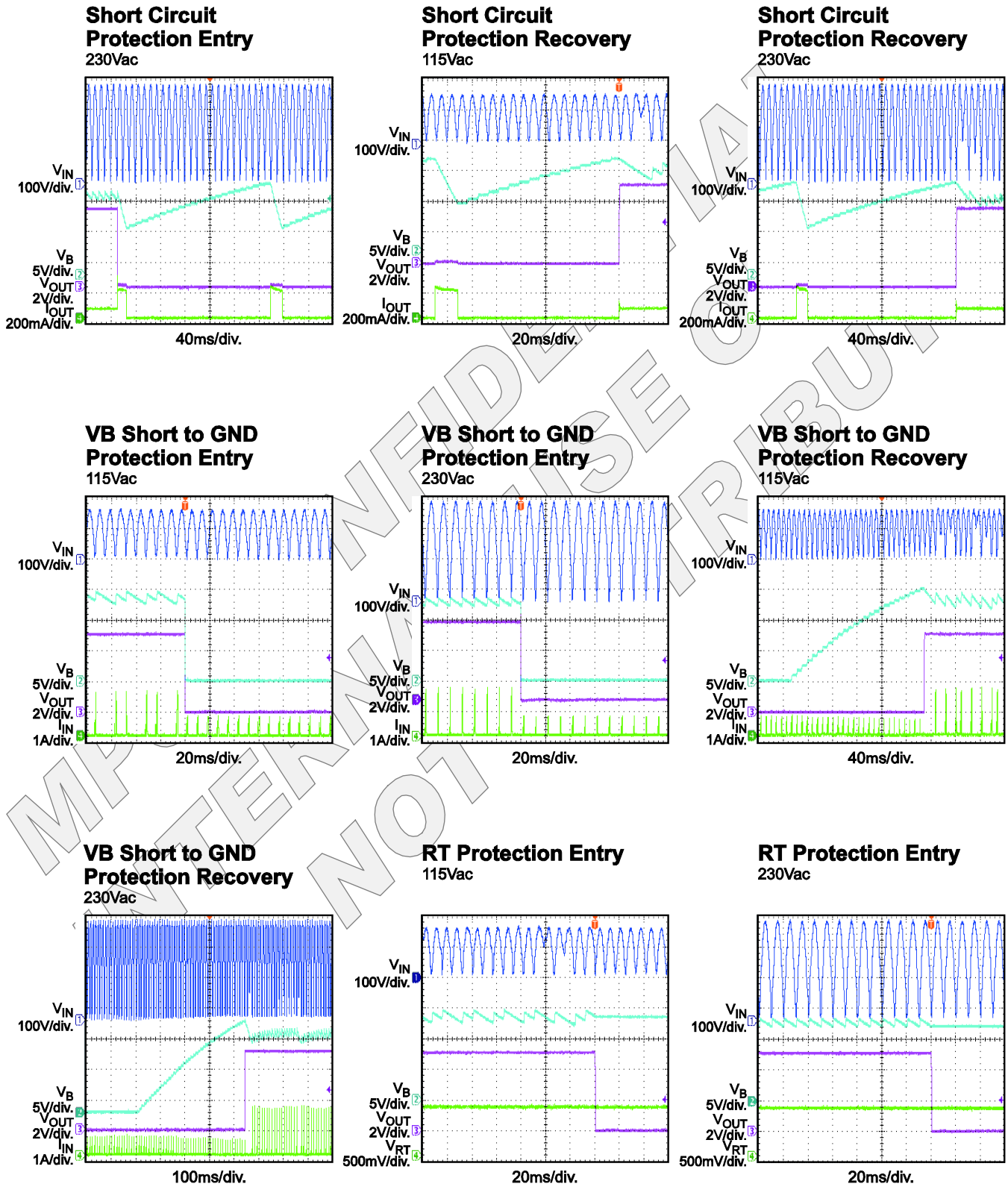
Load Transient
 230Vac, 5V, 0 to 60mA

Over Load Protection Entry
 115Vac

Over Load Protection Entry
 230Vac

Over Load Protection Recovery
 115Vac

Over Load Protection Recovery
 230Vac

Short Circuit Protection Entry
 115Vac

EVB TEST RESULTS *(continued)*

Performance waveforms are tested on the evaluation board.

 $V_{OUT} = 5V$, $I_{OUT} = 60mA$, $T_A = 25^{\circ}C$, unless otherwise noted.

EVB TEST RESULTS *(continued)*

Performance waveforms are tested on the evaluation board.

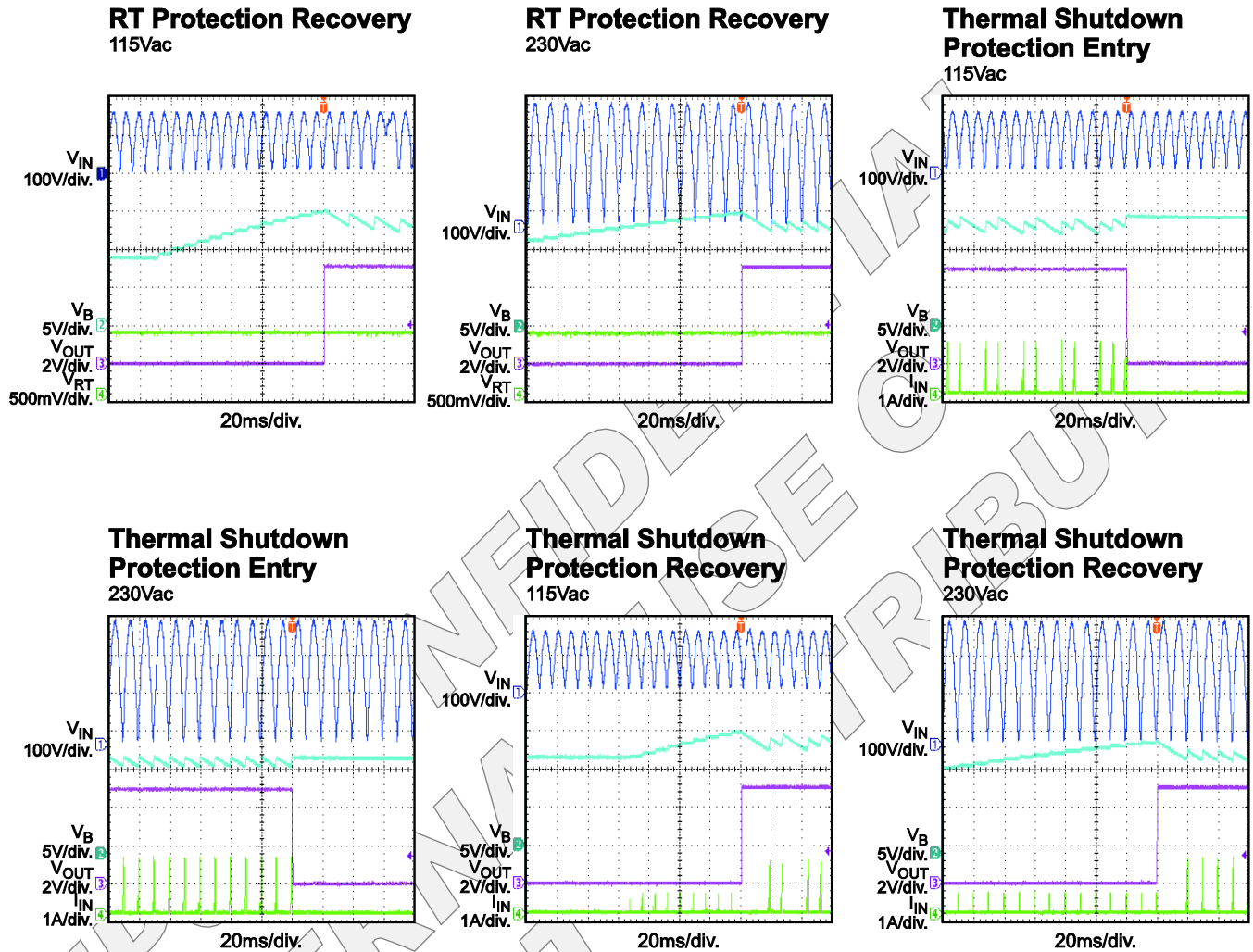
 $V_{OUT} = 5V$, $I_{OUT} = 60mA$, $T_A = 25^{\circ}C$, unless otherwise noted.

EVB TEST RESULTS *(continued)*

Performance waveforms are tested on the evaluation board.

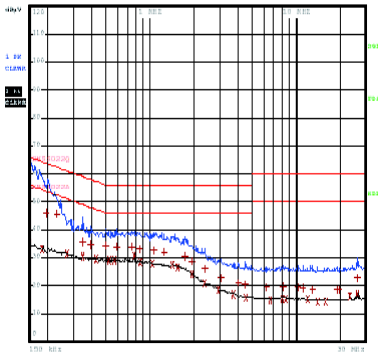
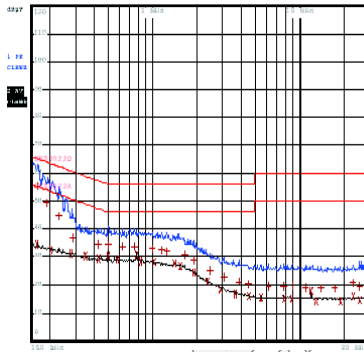
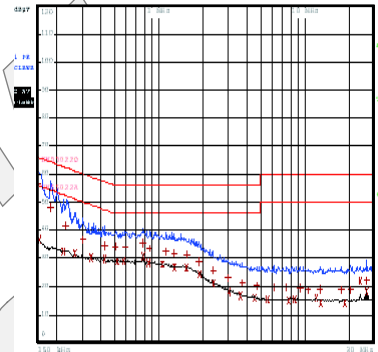
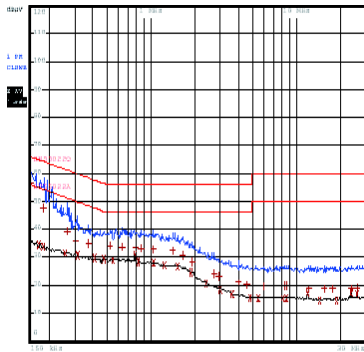
 $V_{OUT} = 5V$, $I_{OUT} = 60mA$, $T_A = 25^{\circ}C$, unless otherwise noted.**EMI Performance**
115Vac, L Line**EMI Performance**
115Vac, N Line**EMI Performance**
230Vac, L Line**EMI Performance**
230Vac, N Line

PRINTED CIRCUIT BOARD LAYOUT

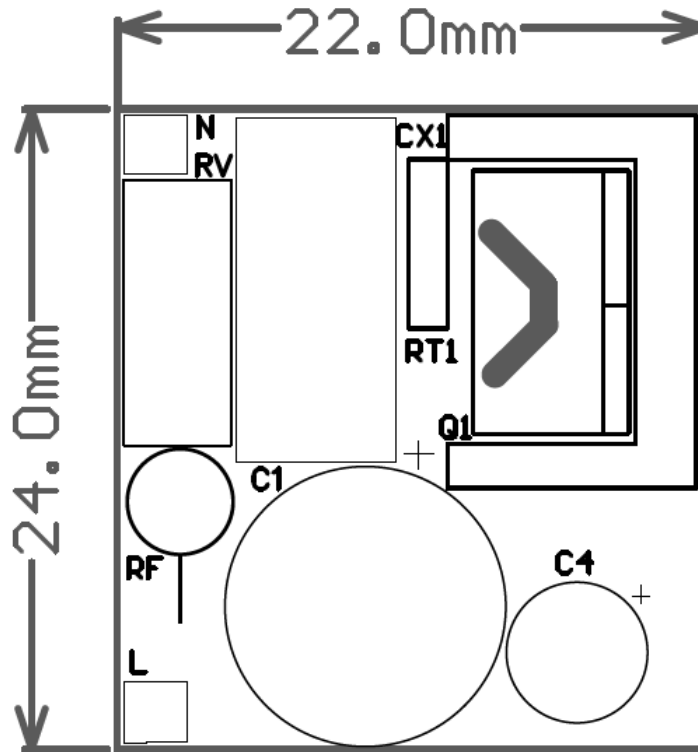

Figure 1 — Top Silk Layer

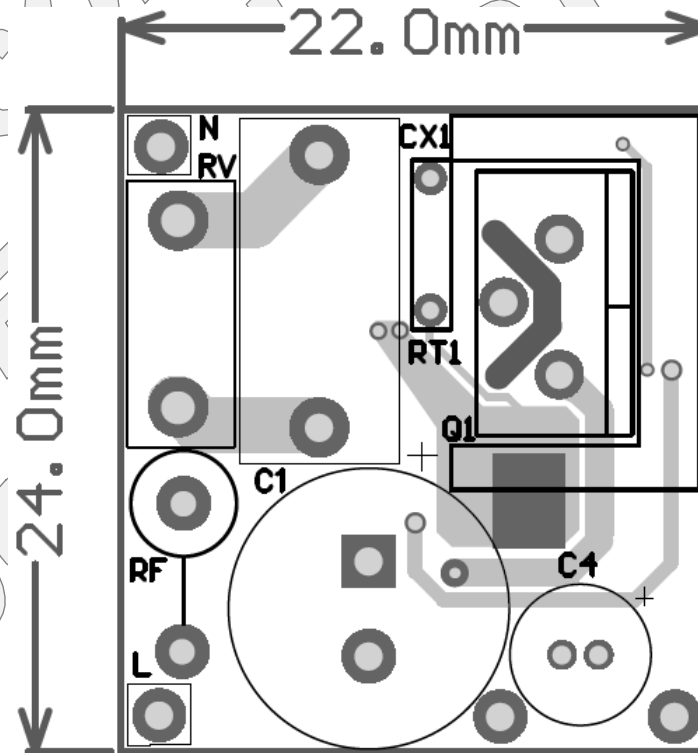

Figure 2 — Top Layer

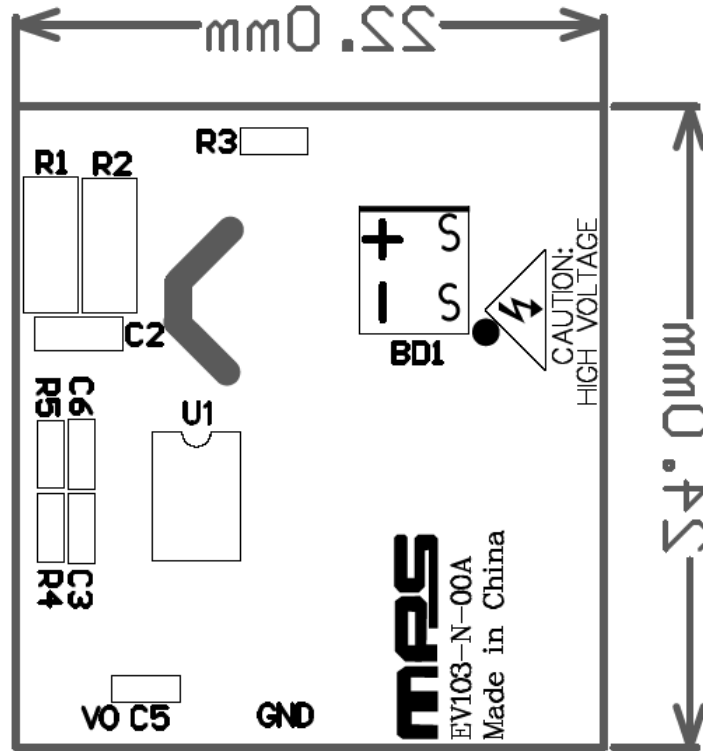

Figure 3 — Bottom Silk

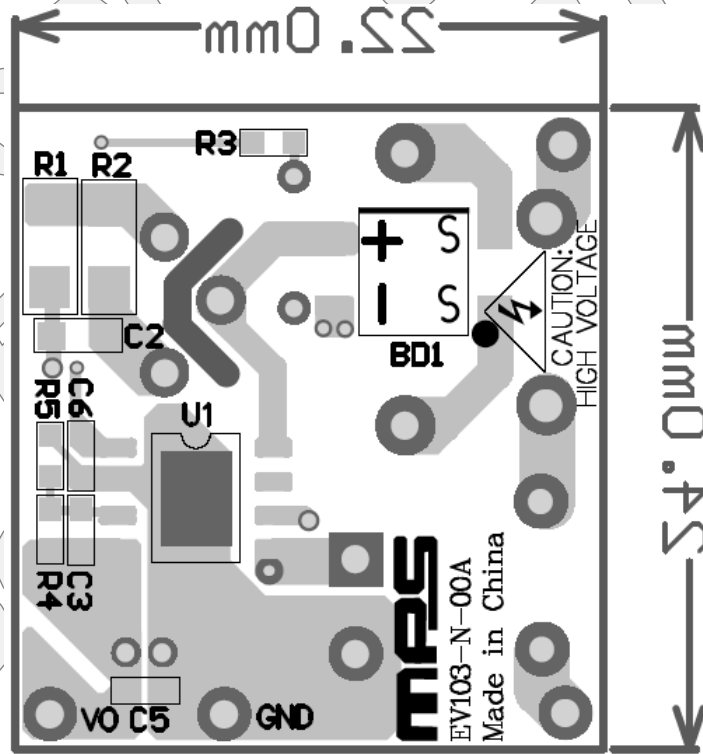

Figure 4 — Bottom Layer

QUICK START GUIDE

1. Preset Power Supply to $85V \leq V_{IN} \leq 265V$.
2. Turn Power Supply off.
3. Connect the Line and Neutral terminals of the power supply output to L and N ports.
4. Connect Load to VO and GND ports.
5. Turn Power Supply on after making connections.

Contact Information

To request this evaluation board, please refer to your local sales offices which can be found from:

<http://www.monolithicpower.com/Company/Contact-Us>

Disclaimer

Monolithic Power Systems (MPS) reserves the right to make changes to its products and to discontinue products without notice. The applications information, schematic diagrams, and other reference information included herein is provided as a design aid only and are therefore provided as-is. MPS makes no warranties with respect to this information and disclaims any implied warranties of merchantability or non-infringement of third-party intellectual property rights.

MPS cannot assume responsibility for use of any circuitry other than circuitry entirely embodied in a MPS product. No circuit patent licenses are implied.

Certain applications using semiconductor products may involve potential risks of death, personal injury, or severe property or environmental damage (“Critical Applications”).

MPS PRODUCTS ARE NOT DESIGNED, INTENDED, AUTHORIZED, OR WARRANTED TO BE SUITABLE FOR USE IN LIFE-SUPPORT APPLICATIONS, DEVICES OR SYSTEMS, OR OTHER CRITICAL APPLICATIONS.

Inclusion of MPS products in critical applications is understood to be fully at the risk of the customer. Questions concerning potential risk applications should be directed to MPS.

MPS semiconductors are typically used in power supplies in which high voltages are present during operation. High voltage safety precautions should be observed in design and operation to minimize the chance of injury.

NOTICE: The information in this document is subject to change without notice. Please contact MPS for current specifications. Users should warrant and guarantee that third party Intellectual Property rights are not infringed upon when integrating MPS products into any application. MPS will not assume any legal responsibility for any said applications.