

Evaluation Board Report

12V 3.6W ACDC power supply

Design Specs	Value	Unit
Input Voltage	85-265	VAC
Output Voltage	12	VDC
Output Current	0.3	A
Isolation	No	
MPS IC	MP174GS	
Application	Home Appliance, white goods, consumer electronics Industrial Controls Standby Power	

Document Number	EBXXX
Author	Application Engineering Department
Date	Nov, 2014
Revision	1.0

Design Summary

EV174-S-00A evaluation board provides a reference design for a universal offline power supply with 12V, 0,3A output. It contains the complete specification of the power supply, a detailed circuit diagram, the entire bill of materials required to build the power supply, drawing of the power inductors and transformers, and test data of the most important performance.

DESCRIPTION

The EV174-S-00A Evaluation Board is designed to demonstrate the capabilities of MP174. The MP174 is a primary-side constant voltage regulator providing accurate constant voltage (CV) regulation without Opto-coupler. It supports Buck, Buck-Boost, Boost and Flyback topologies.

The EV174-S-00A Evaluation Board is designed as Buck application. EV174-S-00A typically drives a 3.6W with a 12V/300mA load from 85VAC to 265VAC, at 60/50Hz.

The EV174-S-00A has an excellent efficiency and meets IEC61000-4-5 surge immunity and EN55022 conducted EMI requirements. MP174 features various protections, including thermal shutdown (TSD), VCC under-voltage lockout (UVLO), over-load protection (OLP), short-circuit protection (SCP), and open loop protection.

MP174GS is available in SOIC8 package.

ELECTRICAL SPECIFICATION

Parameter	Symbol	Value	Units
Input Voltage	V_{IN}	85 to 265	VAC
Output Voltage	V_{OUT}	12	V
Output Current	I_{OUT}	0.3	A
Output Power	P_{OUT}	3.6	W
Efficiency (full load)	η	>75	%

FEATURES

- Primary-Side non-isolated Constant Voltage (CV) Control
- Integrated 700V13.5ΩMOSFET
- < 100mW No-load power consumption
- Up to 3.6W output power
- Peak-Current Control with Peak Current Compression
- Low Vcc operating current
- Limited Maximum Frequency
- Frequency Foldback
- Multiple Protections: SCP, OCP, OTP, and VCC UVLO
- Low Cost and Simple External circuit
- Internal high-voltage current source

All MPS parts are lead-free and adhere to the RoHS directive. For MPS green status, please visit MPS website under Quality Assurance, "MPS" and "The Future of Analog IC Technology", are Registered Trademarks of Monolithic Power Systems, Inc.



Warning: Although this board is designed to satisfy safety requirements, the engineering prototype has not been agency approved. Therefore, all testing should be performed using an isolation transformer to provide the AC input to the prototype board.

EV174-S-00A EVALUATION BOARD



TOP VIEW



BOTTOM VIEW

(L x W x H) 68mm x 28mm x 17mm

Board Number	MPS IC Number
EV174-S-00A	MP174GS

EVALUATION BOARD SCHEMATIC

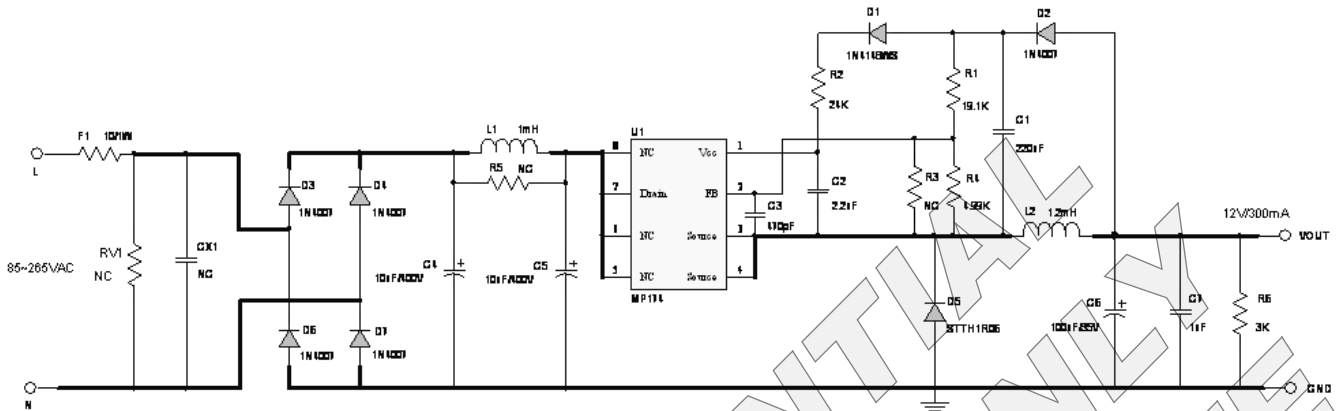

Figure 1—Schematic

PCB LAYOUT (SINGLE-SIDED)

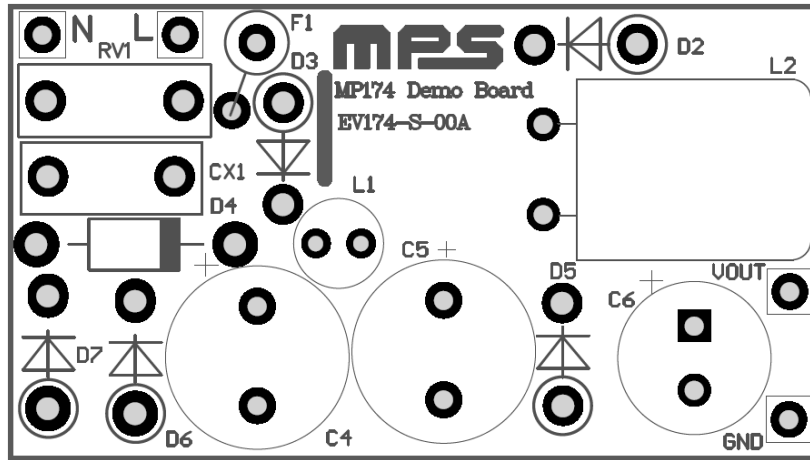

Figure 2—Top Layer

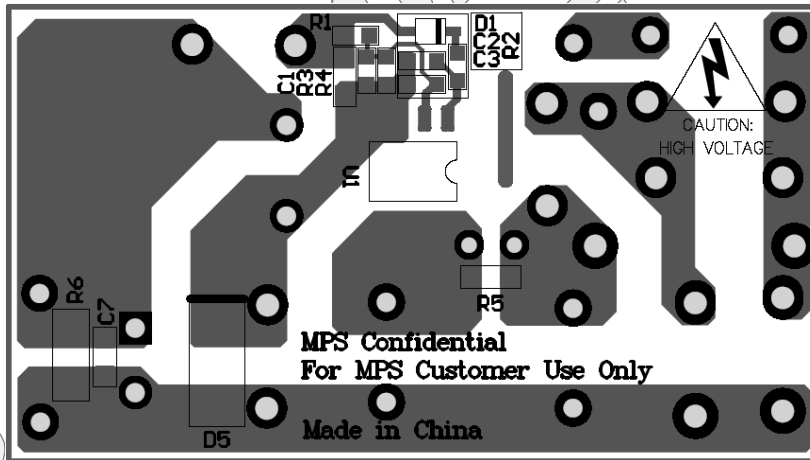

Figure 3—Bottom Layer

EV174-S-00A BILL OF MATERIALS

Qty	Ref	Value	Description	Package	Manufacture	Manufacture_PN
1	C1	220nF	Ceramic Capacitor;16V;X7R	0603	muRata	GRM188R71C224KA01D
1	C2	2.2μF	Ceramic Capacitor;10V;X7R	0603	muRata	GRM188R71A225KE15D
1	C3	470pF	Ceramic Capacitor;50V;X7R	0603	muRata	GRM188R71H471KA01D
2	C4, C5	10μF	Electrolytic Capacitor;400V;20%	DIP	Any	Any
1	C6	100μF	Electrolytic Capacitor;35V	DIP	Jianghai	CD287-35V100
1	C7	1μF	Ceramic Capacitor;16V;X7R	0603	muRata	GRM188R71C105KA12D
1	D1	1N4148WS	Diode;75V;0.15A;	SOD-323	Diodes	1N4148WS-7-F
5	D2, D3, D4, D6, D7	1N4007	Diode;1000V;1A	DO-41	Diodes	1N4007
1	D5	STTH1R06	Diode;600V;1A	DO-41	ST	STTH1R06
1	F1	10Ω	Resistor;5%;1W	DIP	Yageo	FKN1WSJT-52-10R
1	L1	1mH	Inductor;1000uH;8Ω;0.1A	DIP	Any	Any
1	L2	1.2mH	Inductor;1.2mH;1.8Ω;400mA	DIP	Emei	DR9X12P2M1.2-00
1	R1	19.1kΩ	Film Resistor;1%	0603	Yageo	RC0603FR-0719K1L
1	R2	24kΩ	Film Resistor;1%	0603	Yageo	RC0603FR-0724KL
1	R4	4.99kΩ	Film Resistor;1%	0603	Yageo	RC0603FR-074K99L
1	R6	3kΩ	Film Resistor;1%	1206	Yageo	RC1206FR-073KL
1	U1	MP174	Primary side regulator	SOIC8	MPS	MP174GS

CIRCUIT DESCRIPTION

The EV174-S-00A is configured in a buck regulator topology, it uses primary-side-control which can mostly simplify the schematic and get a cost effective BOM. It can also achieve accurate constant voltage and acceptable cross regulation.

F1 is used to protect circuit from component failure or some excessive short events; also it can restrain the inrush current.

C4, L1 and C5 compose π filter to guarantee the conducted EMI meet standard EN55022. C2 and C3 are also used for energy storage and protecting against line surge.

R2, C2, and D1 are used as VCC power supply. Though MP174 is equipped with an internal high voltage current source, using this circuit can achieve better efficiency.

C1 is the sample-hold capacitor, used for reflecting output voltage. R1 and R4 are resistor divider for detecting output voltage by sampling voltage on C1.

D5 is the freewheeling diode. For universal voltage applications, use a diode with a 600V reverse block voltage. Ultra-fast recovery diode is recommended for better efficiency.

C6 and C7 are output capacitors for 12V output. C6 should be low ESR electrolytic capacitor for better output ripple. C7 is ceramic capacitor to reduce high frequency voltage ripple. R6 is dummy load to lower the output voltage of 12V rail at no load condition.

Surge Performance

Line to Line 1kV surge tested according to IEC61000-4-5.

Input voltage was set at 230VAC/50Hz. Output was loaded at full load and operation was verified following each surge event.

Surge Level (V)	Input Voltage (VAC)	Injection Location	Injection Phase (°)	Test Result (Pass/Fail)
1000	230	L to N	0	Pass
1000	230	L to N	90	Pass
1000	230	L to N	180	Pass
1000	230	L to N	270	Pass
-1000	230	L to N	0	Pass
-1000	230	L to N	90	Pass
-1000	230	L to N	180	Pass
-1000	230	L to N	270	Pass

The board can pass 2kV surge test by simple using 2 10ohm/1W fuse resistor, as the circuit show below.

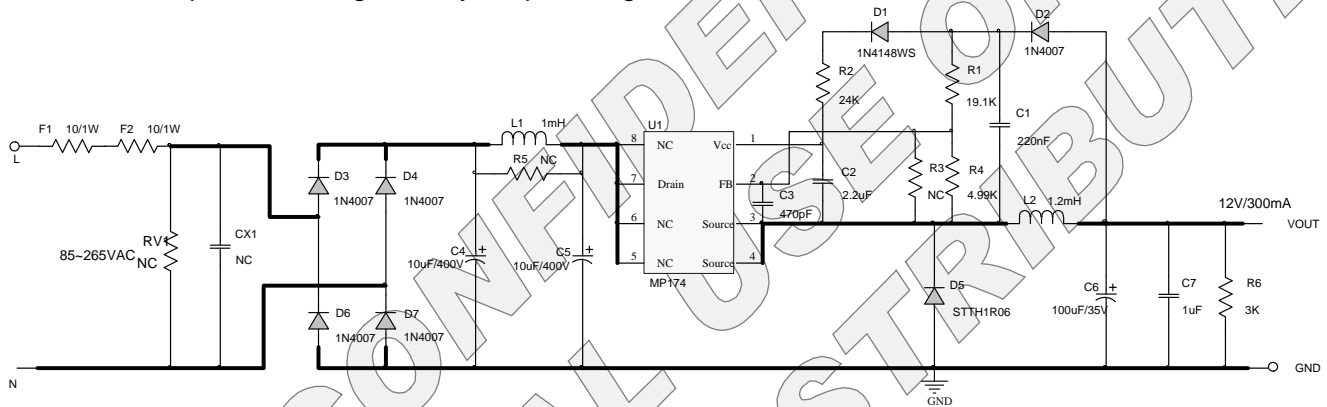

EVB TEST RESULTS

Performance waveforms are tested on the evaluation board.

$V_{IN}=85-265V_{AC}$, $V_{OUT}=12V$, $I_{OUT}=0.3A$ CC Mode Load, $T_A=22^{\circ}C$

Efficiency

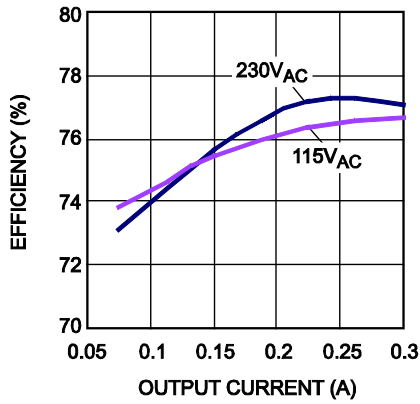

No Load Consumption

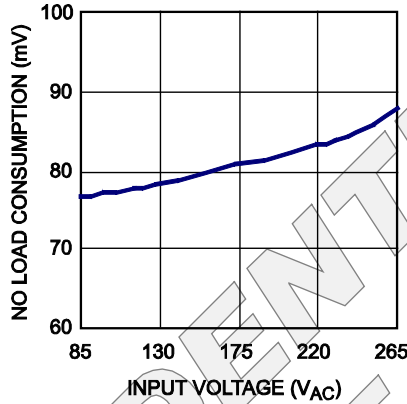

Steady State

$V_{IN}=115V_{AC}$, Full Load

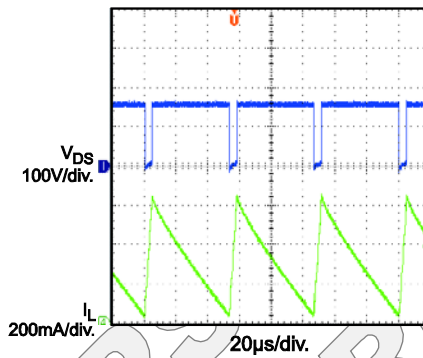

Steady State

$V_{IN}=230V_{AC}$, Full Load

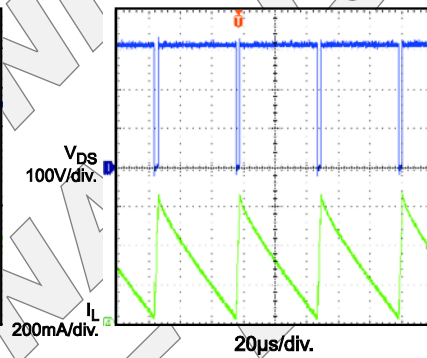

Output Ripple

$V_{IN}=115V_{AC}$, No Load

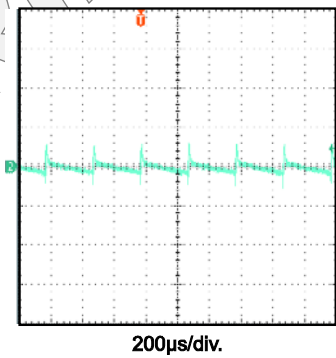

Output Ripple

$V_{IN}=115V_{AC}$, Full Load

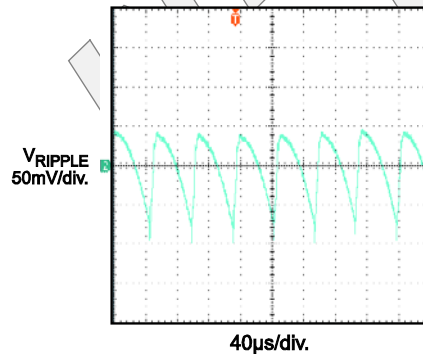

Output Ripple

$V_{IN}=230V_{AC}$, No Load

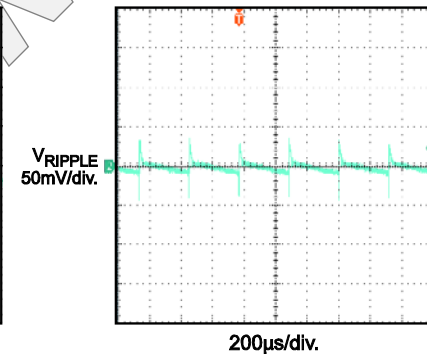

Output Ripple

$V_{IN}=230V_{AC}$, Full Load

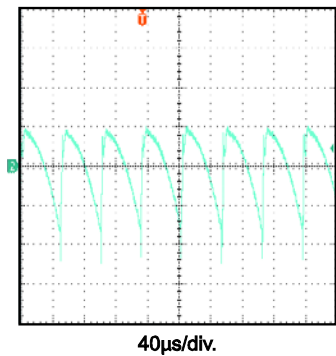

EVB TEST RESULTS (continued)

Performance waveforms are tested on the evaluation board.

$V_{IN}=85-265V_{AC}$, $V_{OUT}=12V$, $I_{OUT}=0.3A$, CC Mode Load, $T_A=22^{\circ}C$

Soft Start

$V_{IN}=85V_{AC}$

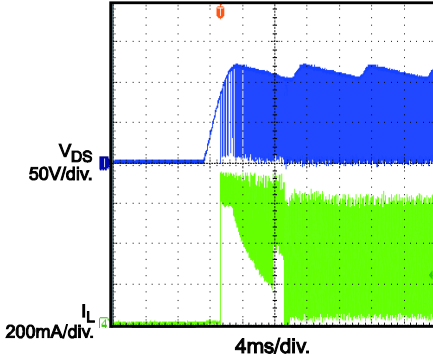

Soft Start

$V_{IN}=265V_{AC}$

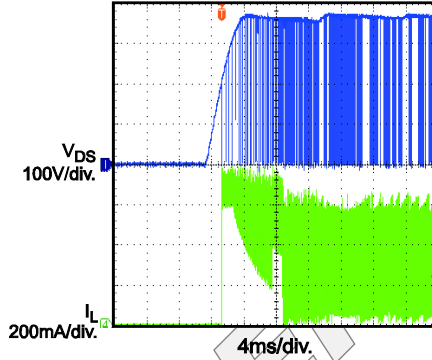

Turn-On Delay

$V_{IN}=115V_{AC}$, No Load

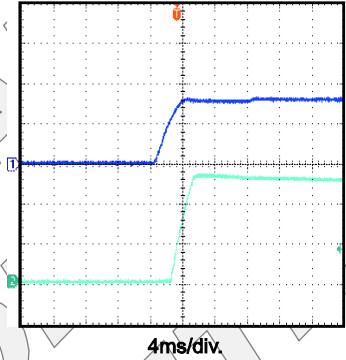

Turn-On Delay

$V_{IN}=115V_{AC}$, Full Load

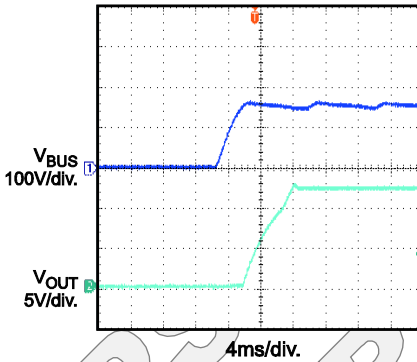

Turn-On Delay

$V_{IN}=230V_{AC}$, No Load

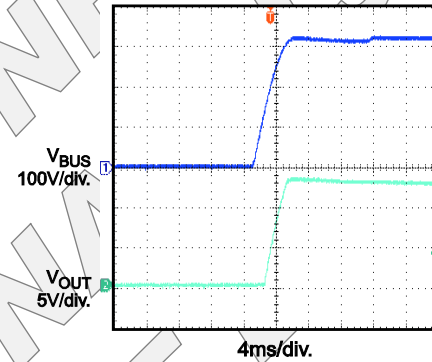

Turn-On Delay

$V_{IN}=230V_{AC}$, Full Load

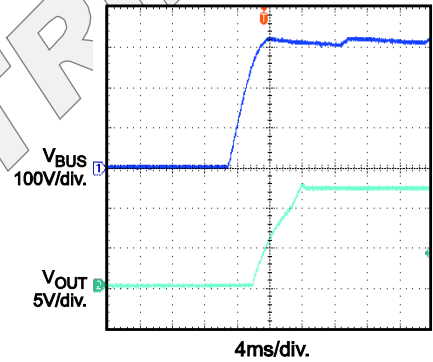

Load Transient

$V_{IN}=115V_{AC}$, 25%-50% Load

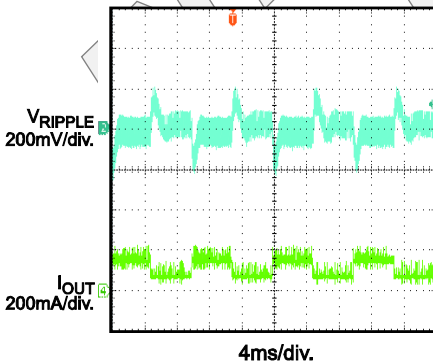

Load Transient

$V_{IN}=115V_{AC}$, 50%-75% Load

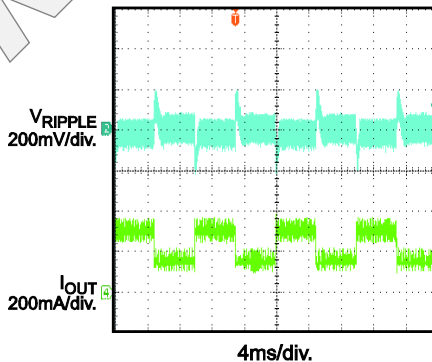

Load Transient

$V_{IN}=230V_{AC}$, 25%-50% Load

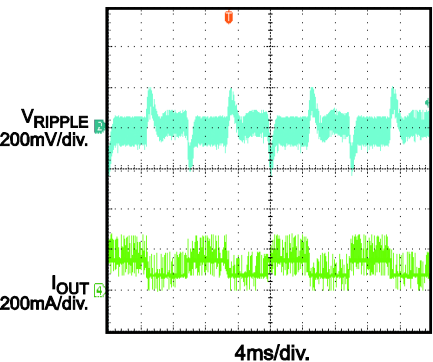

EVB TEST RESULTS (continued)

Performance waveforms are tested on the evaluation board.

$V_{IN}=85-265V_{AC}$, $V_{OUT}=12V$, $I_{OUT}=0.3A$, CC Mode Load, $T_A=22^{\circ}C$

Load Transient

$V_{IN}=230V_{AC}$, 50%-75% Load

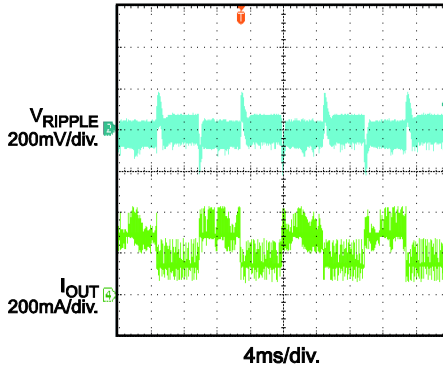

OTP

$V_{IN}=230V_{AC}$

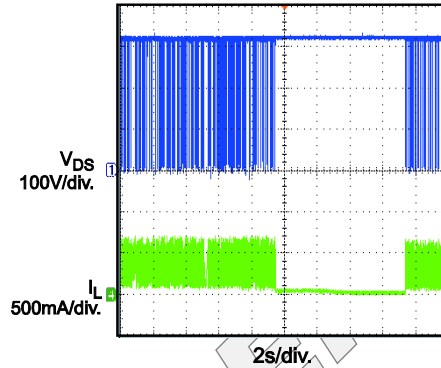

SCP

$V_{IN}=230V_{AC}$

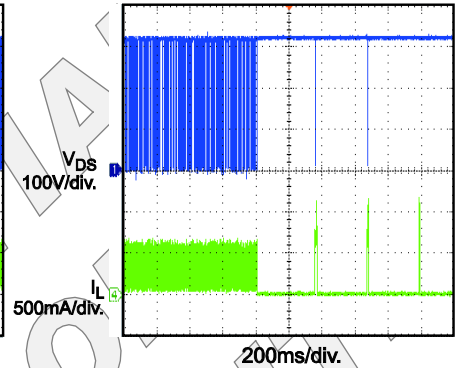

Open Loop Protection

$V_{IN}=230V_{AC}$, No Load

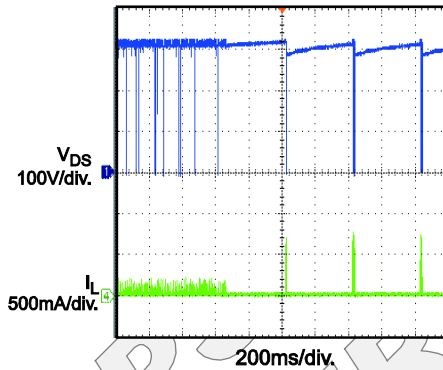

Open Loop Protection

$V_{IN}=230V_{AC}$, Full Load

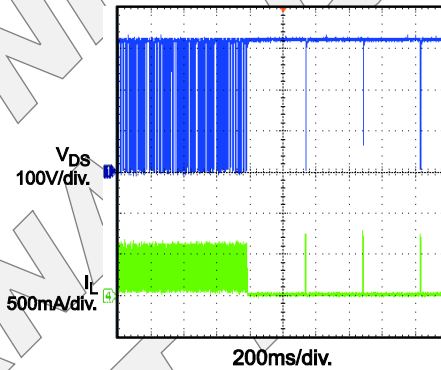

EVB TEST RESULTS (continued)

Performance waveforms are tested on the evaluation board.

$V_{IN}=85-265V_{AC}$, $V_{OUT}=12V$, $I_{OUT}=0.3A$, CC Mode Load, $T_A=22^{\circ}C$

Conducted EMI

Two-Wire Input, $V_{IN}=115V_{AC}$, L Line

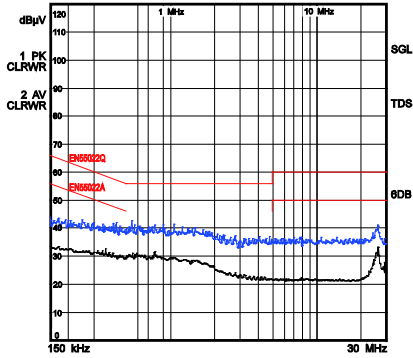

Conducted EMI

Two-Wire Input, $V_{IN}=115V_{AC}$, N Line

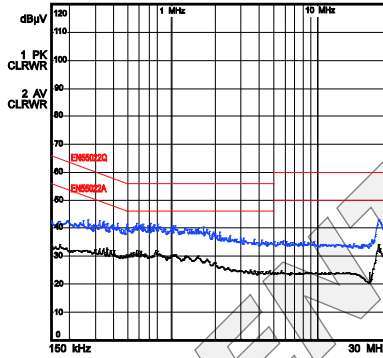

Conducted EMI

Two-Wire Input, $V_{IN}=230V_{AC}$, L Line

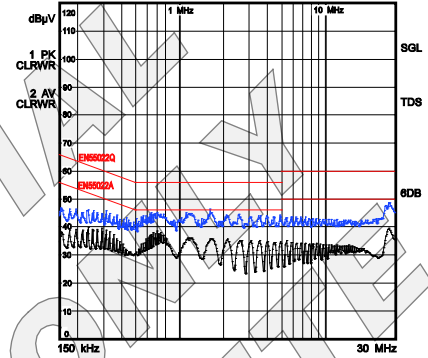

Conducted EMI

Two-Wire Input, $V_{IN}=230V_{AC}$, N Line

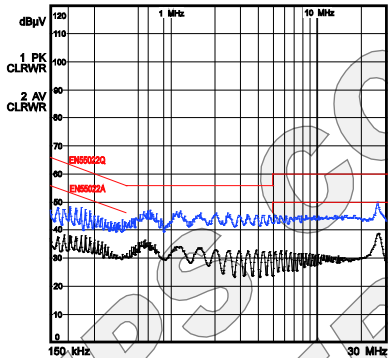

QUICK START GUIDE

1. Preset Power Supply to $85\text{VAC} \leq V_{\text{IN}} \leq 265\text{VAC}$.
2. Turn Power Supply off.
3. Connect the Line and Neutral terminals of the power supply output to L and N port. For three-wire input application, make OUTPUT GND connected to Earth.
4. Connect Different Load to Corresponding Outputs :
 - a. Positive (+): 12V OUT
 - b. Negative (-): GND
5. Turn Power Supply on after making connections.

Contact Information

To request this evaluation board, please refer to your local sales offices which can be found from:

<http://www.monolithicpower.com/Company/Contact-Us>

Disclaimer

Monolithic Power Systems (MPS) reserves the right to make changes to its products and to discontinue products without notice. The applications information, schematic diagrams, and other reference information included herein is provided as a design aid only and are therefore provided as-is. MPS makes no warranties with respect to this information and disclaims any implied warranties of merchantability or non-infringement of third-party intellectual property rights.

MPS cannot assume responsibility for use of any circuitry other than circuitry entirely embodied in a MPS product. No circuit patent licenses are implied.

Certain applications using semiconductor products may involve potential risks of death, personal injury, or severe property or environmental damage ("Critical Applications").

MPS PRODUCTS ARE NOT DESIGNED, INTENDED, AUTHORIZED, OR WARRANTED TO BE SUITABLE FOR USE IN LIFE-SUPPORT APPLICATIONS, DEVICES OR SYSTEMS, OR OTHER CRITICALAPPLICATIONS.

Inclusion of MPS products in critical applications is understood to be fully at the risk of the customer. Questions concerning potential risk applications should be directed to MPS.

MPS semiconductors are typically used in power supplies in which high voltages are present during operation. High voltage safety precautions should be observed in design and operation to minimize the chance of injury.

NOTICE: The information in this document is subject to change without notice. Please contact MPS for current specifications. Users should warrant and guarantee that third party Intellectual Property rights are not infringed upon when integrating MPS products into any application. MPS will not assume any legal responsibility for any said applications.