

HFC0500+MP6902

Customer Support Test Report

AE	John Liu
Manager	En Li
Date	2014-07-10

1.	Specification		
2.	Schematic		
3.	Circuit Board		
3.1	PCB Layout		
4.	Bill of Materials		
5.	Transformer Information		
5.1	Winding Spec		
5.2	Winding Details		
6.	Performance Data		
6.1	Test Setup		
6.1.1	Test Equipment		
6.2	Efficiency		
6.2.1	Active Mode Efficiency		
6.2.2	No-load Power Consumption		
6.3	Stress		
6.3.1	Mosfet V_{DS}		
6.3.2	Output Mosfet V_{ds}		
6.4	Protection		
6.4.1	Short Circuit Protection		
6.4.2	Over Current Protection		
6.4.3	Output Over Voltage Protection		
6.5	Output and Timing		
6.5.1	Load Regulation		
6.5.2	Output Ripple		
6.5.3	Transient Response		
6.5.4	Turn-on Delay and Output Rise Time		
6.6	Thermal		
6.6.1	Parts Thermal		
6.7	EMC and Safety		
6.7.1	Conducted Emission		

1. Specification

Description	Parameter	Units	Comment
Input voltage	90~264	V _{AC}	
Input frequency	47~53	Hz	
Output voltage	12	V	
Output current	5	A	

2. Schematic

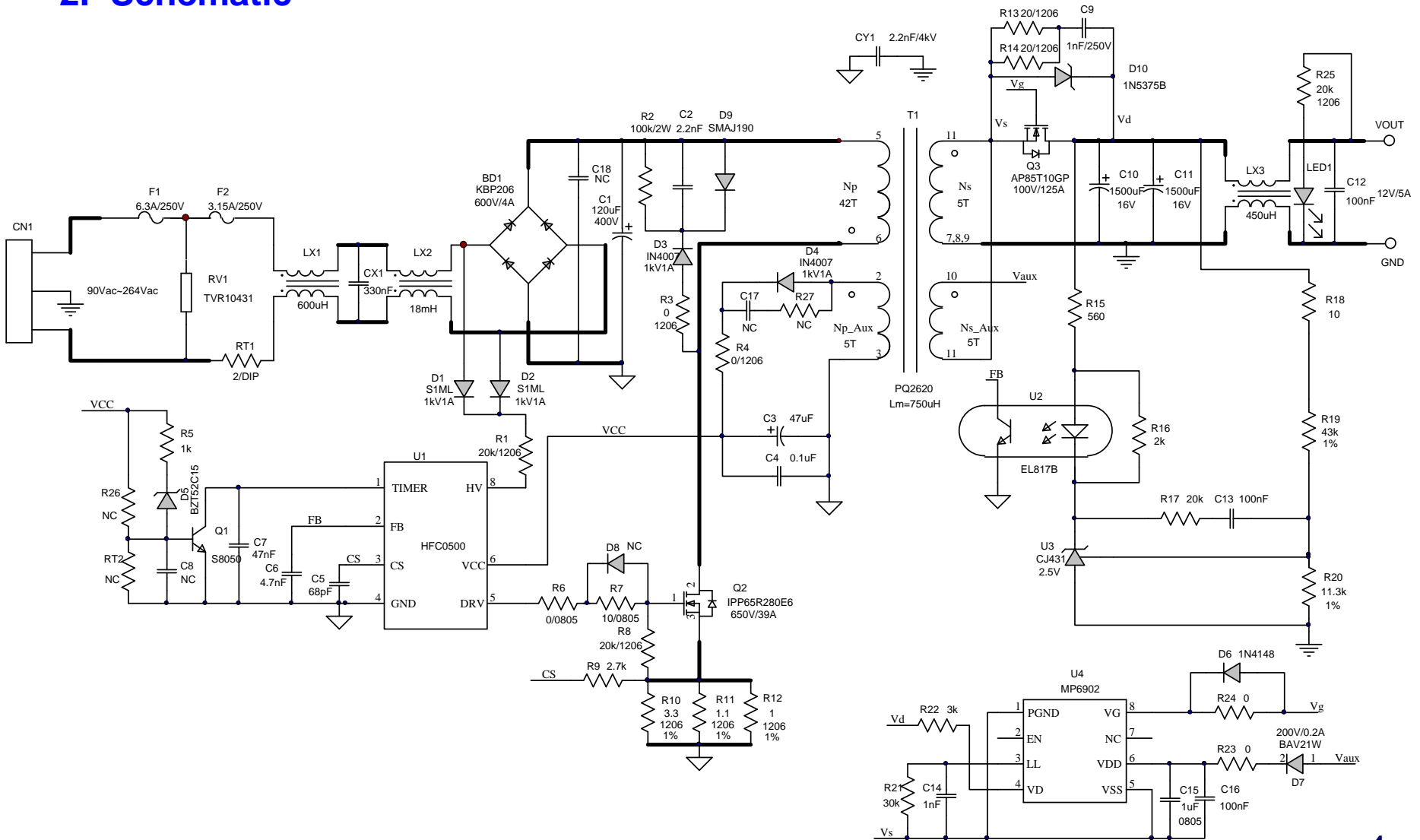

3. Circuit Board

3.1 PCB Layout

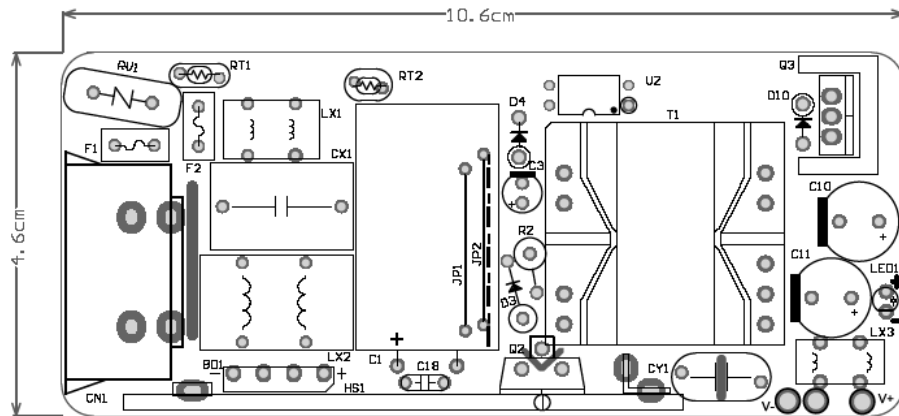

TOP & TSK

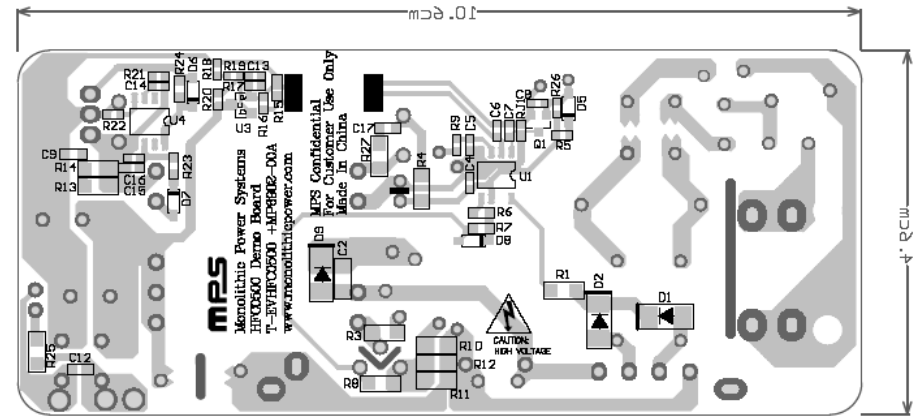

BOT & BSK

4. Bill of Materials (Main Board)

Qty	RefDes	Value	Description	Package	Manufacturer	Manufacturer_PN
1	BD1	KBP206	Diode;600V;2A	DIP	Bangdayuan	KBP206
1	C1	120uF	Electrolytic Capacitor;400V;	DIP	Jianghai	CD267-400V120
1	C2	2.2nF	Ceramic Capacitor;630V	1206	muRata	
1	C3	47uF	Electrolytic Capacitor;25V;	DIP	Jianghai	CD286-25V47
3	C4,C13,C16	100nF	Ceramic Capacitor;50V;X7R;	0603	muRata	GRM188R71H104KA93D
1	C5	68pF	Ceramic Capacitor;50V;C0G;	0603	TDK	C1608COG1H680J
1	C6	4.7nF	Ceramic Capacitor;50V;X7R;	0603	TDK	C1608X7R1H471K
1	C7	47nF	Ceramic Capacitor;50V;X7R;	0603	muRata	GRM188R71H473KA61D
0	C8,C17,C18	NC				
1	C9	1nF	Capacitor;250V;X7R;	0805	TDK	C2012X7R2E102K
2	C10,C11	1500uF	Electrolytic Capacitor;16V	DIP	Any	Any
1	C12	100nF	Ceramic Capacitor;25V;X7R;	0805	muRata	GRM21BR71E104KA01L
1	C14	1nF	Ceramic Capacitor;25V;C0G;	0603	muRata	GRM1885C1E102JA01D
1	C15	1uF	Ceramic Capacitor;50V;X7R;	0805	muRata	GRM21BR71H105KA12L
1	CN1		Connector	DIP	Any	Any
1	CX1	330nF	Capacitor;275V;10%	DIP	Carli	PX334K3ID49L270D9R
1	CY1	2.2nF	Capacitor;4kV;20%	DIP	Hongke	JN12E222MY02N
2	D1,D2	S1ML	Diode;1000V;1A	SMA	Taiwan Semiconductor	S1ML
2	D3,D4	1N4007	Diode;1000V;1A	DO-41	Diodes	1N4007
1	D5	BZT52C16	Zener Diode;16V;5mA/500mW;	SOD-123	Diodes	BZT52C16

...Continued

Qty	RefDes	Value	Description	Package	Manufacturer	Manufacturer_PN
1	D6	1N4148	Schottky Diode;40V;0.5A	SOD-123	Diodes	B0540W
1	D7	BAV21W	Diode;200V;0.2A;	SOD-123	Diodes	BAV21W-7-F
1	D8	NC				
1	D9	SMAJ190A	Diode;190V;1mA	DO-214AC	Brightking	SMAJ190A
1	D10	1N5375B	Zener Diode;82V;0.015A	DIP	Bangdayuan	1N5375B
1	F1		Fuse;250V;6.3A	DIP	Any	Any
1	F2	SS-5-3.15A	Fuse;250V;3.15A	DIP	Cooper Bussmann	SS-5-3.15A
1	LED1	F3D02R-4A	LED;Red	DIP	Any	F3D02R-4A
1	LX1	600uH	600uH/2A	DIP	Any	Any
1	LX2	18mH	18mH/2A	DIP	Any	Any
1	LX3	450uH	450uH/6A	DIP	Any	Any
1	Q1	S8050	Transistor;25V;0.5A;	SOT-23	Changdian	S8050
1	Q2	IPP65R280E6	Mosfet;650V;0.28ohm/10V;	TO220		IPP65R280E6
1	Q3	AP85T10GP	N-Channel Mosfet;100V;8mohm;	TO-220	APEC	AP85T10GP
3	R1,R8,R25	20kΩ	Film Resistor;5%;	1206	Yageo	RC1206JR-0720KL
1	R2	100kΩ	Resistor;5%;2W	DIP	Any	Any
2	R3,R4	0Ω	Film Resistor;5%	1206	Yageo	RC1206JR-070RL
1	R5	1kΩ	Film Resistor;1%	0603	Yageo	RC0603FR-071KL
3	R6,R23,R24	0Ω	Film Resistor;5%;	0805	Yageo	RC0805JR-070RL
1	R7	10Ω	Film Resistor;1%;	0805	Yageo	RC0805FR-0710RL
1	R9	2.7kΩ	Film Resistor;1%	0603	Yageo	RC0603FR-072K7L

...Continued

Qty	RefDes	Value	Description	Package	Manufacturer	Manufacturer_PN
1	R10	3.3Ω	Film Resistor;1%	1206	Royalohm	1206F330KT5E
1	R11	1.1Ω	Film Resistor;1%	1206	Yageo	RC1206FR-071R1L
1	R12	1Ω	Film Resistor;1%	1206	Royalohm	1206F100KT5E
2	R13,R14	20Ω	Film Resistor;5%	1206	Yageo	RC1206JR-0720RL
1	R15	560Ω	Film Resistor;1%	0603	Yageo	RC0603FR-07560RL
1	R16	2kΩ	Film Resistor;1%	0603	Yageo	RC0603FR-072KL
1	R17	20kΩ	Film Resistor;1%;	0603	Yageo	RC0603FR-0720KL
1	R18	10Ω	Film Resistor;1%;	0603	Yageo	RC0603FR-0710RL
1	R19	43kΩ	Film Resistor;1%	0603	LION	RC0603FR-0743KL
1	R20	11.3kΩ	Film Resistor;1%	0603	Yageo	RC0603FR-0711K3L
1	R21	30kΩ	Film Resistor;5%;	0603	LIZ	CR0603JA0303G
1	R22	3kΩ	Film Resistor;5%	0603	Yageo	RC0603JR-073KL
0	R26,R27	NC				
1	RT1	2Ω	NTC Resistor	DIP	Xingshun	2D2-10
1	RT2	NC				
1	RV1	TVR10431	MOV; 430V/1mA;0.4W;	DIP	TKS	TVR10431
1	T1	750uH	PQ26/25; Np:Ns:Np_aux:Ns_axu=42:5:5:5	DIP	Any	Any
1	U1	HFC0500	Offline controller	SOIC8-7	MPS	HFC0500HS
1	U2	EL817B	Photocoupler;1-Channel	DIP	Sharp	EL817B
1	U3	CJ431	2.5V shut regulator	SOT-23	Changdian	CJ431
1	U4	MP6902DS	SR controller;	SOIC8	MPS	MP6902DS

5. Transformer Information

5.1 Winding Spec

- Primary inductance: **750uH(±5%)**
- Leakage inductance: **40uH(Max)**
- Core/Bobbin: **PQ26/25**
- Core material: **PC40**
- N1:N2:N3:N4:N5:N6=18:5:15:5:5:24

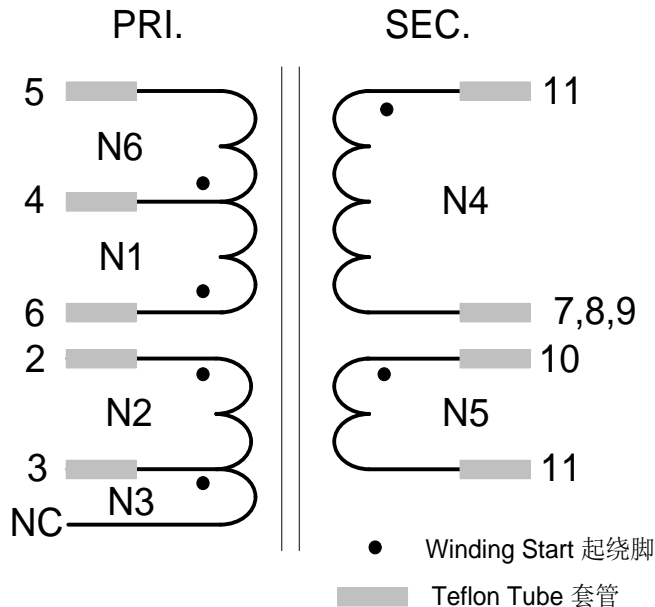

5.2 Winding Details

Winding Order	Pin Number		Wire Type (Φ)	Number of Wires	Number of Turns	Winding Type
	Start	Finish				
N1	6	4	0.32mm	2	18	
N2	2	3	0.2mm	1	5	Spread Out
N3	3	NC	0.2mm	1	15	Spread Out
N4	11	7,8,9	0.6mm(T.I.W)	4	5	
N5	10	11	0.2mm(T.I.W)	1	5	Spread Out
N6	4	5	0.32mm	2	24	

6. Performance Data**6.1 Test Setup****6.1.1 Test Equipment**

- AC Source: **Chroma, Model 61601**
- Power Meter: **Yokogawa, Model WT210**
- E-Load: **Chroma, Model 63101**
- Oscilloscope: **Tektronix, Model TDS3014C**
- Current Probe/Amplifier: **Tektronix, Model TCP202**
- EMC Receiver: **Rohde & Schwarz, Model ESPI3+ESPI-B2**
-

Note: Active mode efficiency at 115V_{AC}/60Hz

6.2 Efficiency

6.2.1 Active Mode Efficiency

Test Conditions:

- The unit was set to maximum load and well pre-heated until temperature stabilization was achieved.
- Temperature stabilization was established for every load step before recording any measurements.

Criteria To Pass:

- The average efficiency must be > **90%**.

...Continued

Input (V _{AC} /Hz)	I _{OUT} (A)	V _{OUT} (V)	P _{OUT} (W)	P _{IN} (W)	Efficiency(%)
115/60	5	12.01	60.05	66.750	89.96
	3.75	12.02	45.075	49.933	90.27
	2.50	12.04	30.10	33.066	91.03
	1.251	12.04	15.062	16.524	91.15
Average Efficiency (%)					90.60
230/50	5	12.01	60.05	66.096	90.85
	3.751	12.02	45.087	49.141	91.75
	2.50	12.03	30.075	33.067	90.95
	1.251	12.04	15.062	16.704	90.17
Average Efficiency (%)					90.93

Comment: Pass

6.2.2 No-load Power Consumption

Test Conditions:

- The unit was set to maximum load and well pre-heated.
- After 5 minutes the load was removed.
- The no-load input power measurements were recorded after stabilization of the input power reading.

Criteria To Pass:

- The power consumption must be < **75mW** at the maximum input voltage.

V _{AC} /Hz	90/60	115/60	230/50	264/50
P _{IN} (mW)	68.91	63.48	68.88	72.68

Comment: Pass

6.3 Stress

6.3.1 Mosfet V_{DS}

Test Conditions:

- The main input voltage was set to $264V_{AC}$.
- The electronic load was set to the maximum output current.

Criteria To Pass:

- The mosfet V_{DS} must be $< 650V$ at both startup and steady status.

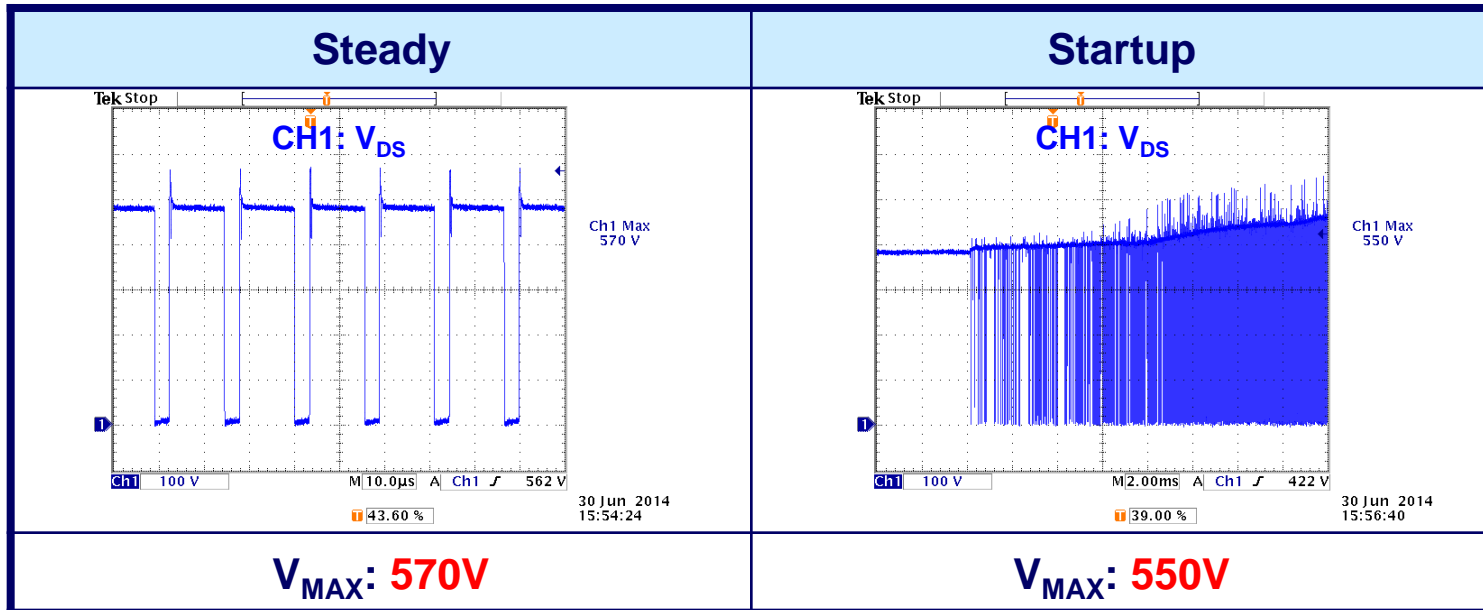

Comment: Pass

...Continued

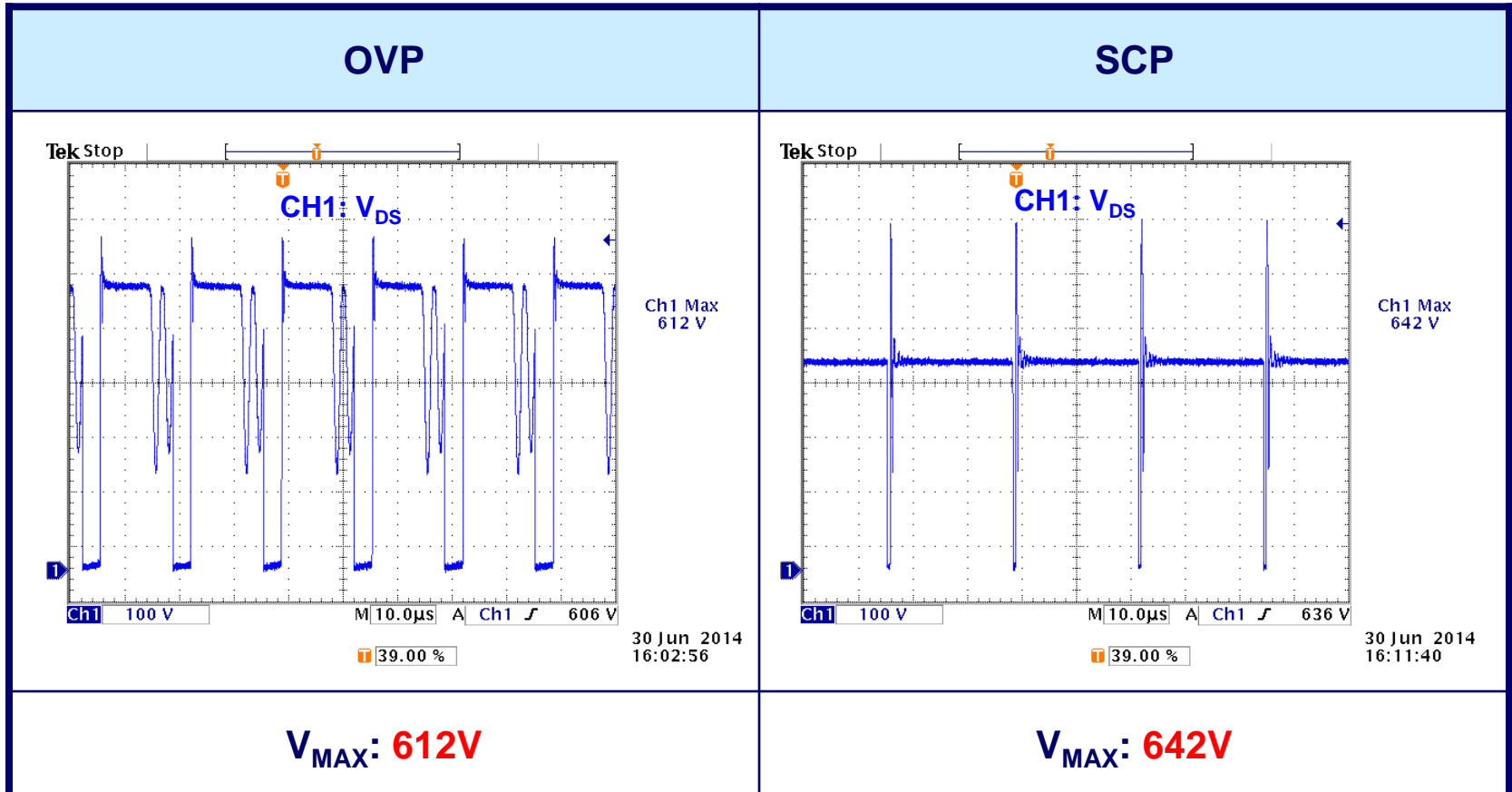

Comment: Pass

6.3.2 Output Mosfet V_{ds}

Test Conditions:

- The main input voltage was set to $264V_{AC}$.
- The electronic load was set to the maximum output current.

Criteria To Pass:

- The diode V_{ds} must be $< 100V$ at both startup and steady status.

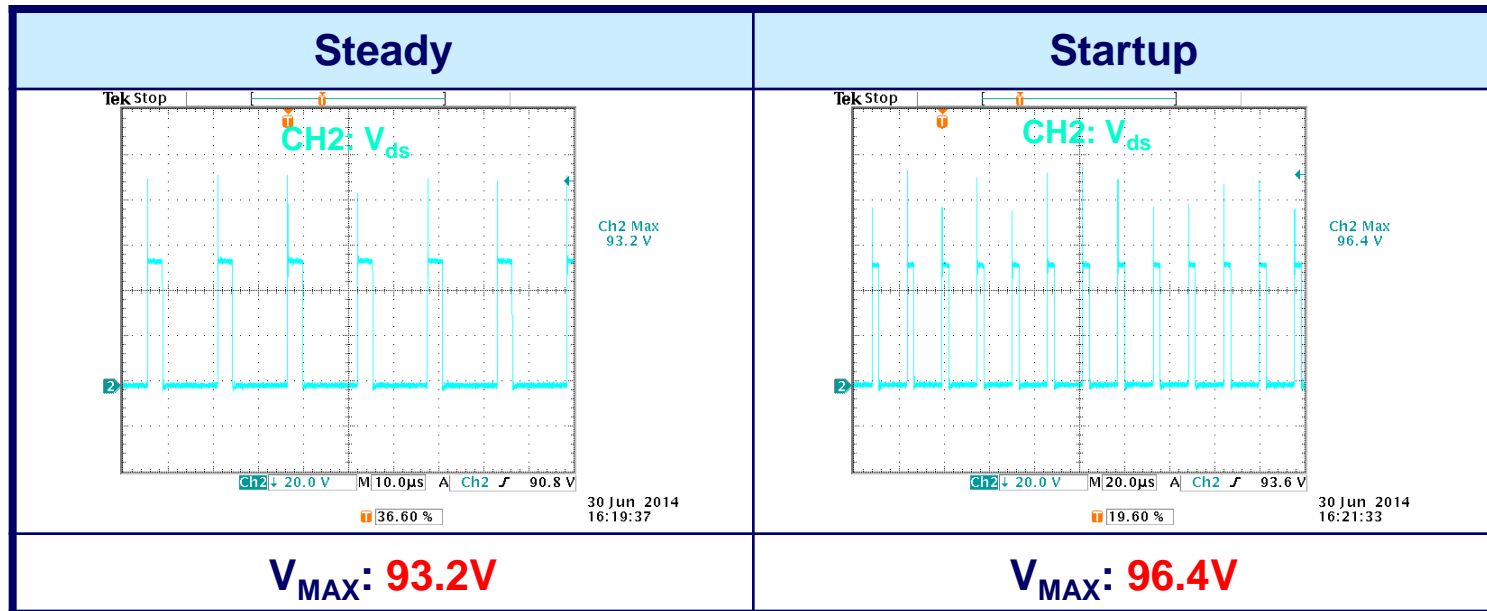

Comment: Pass

...Continued

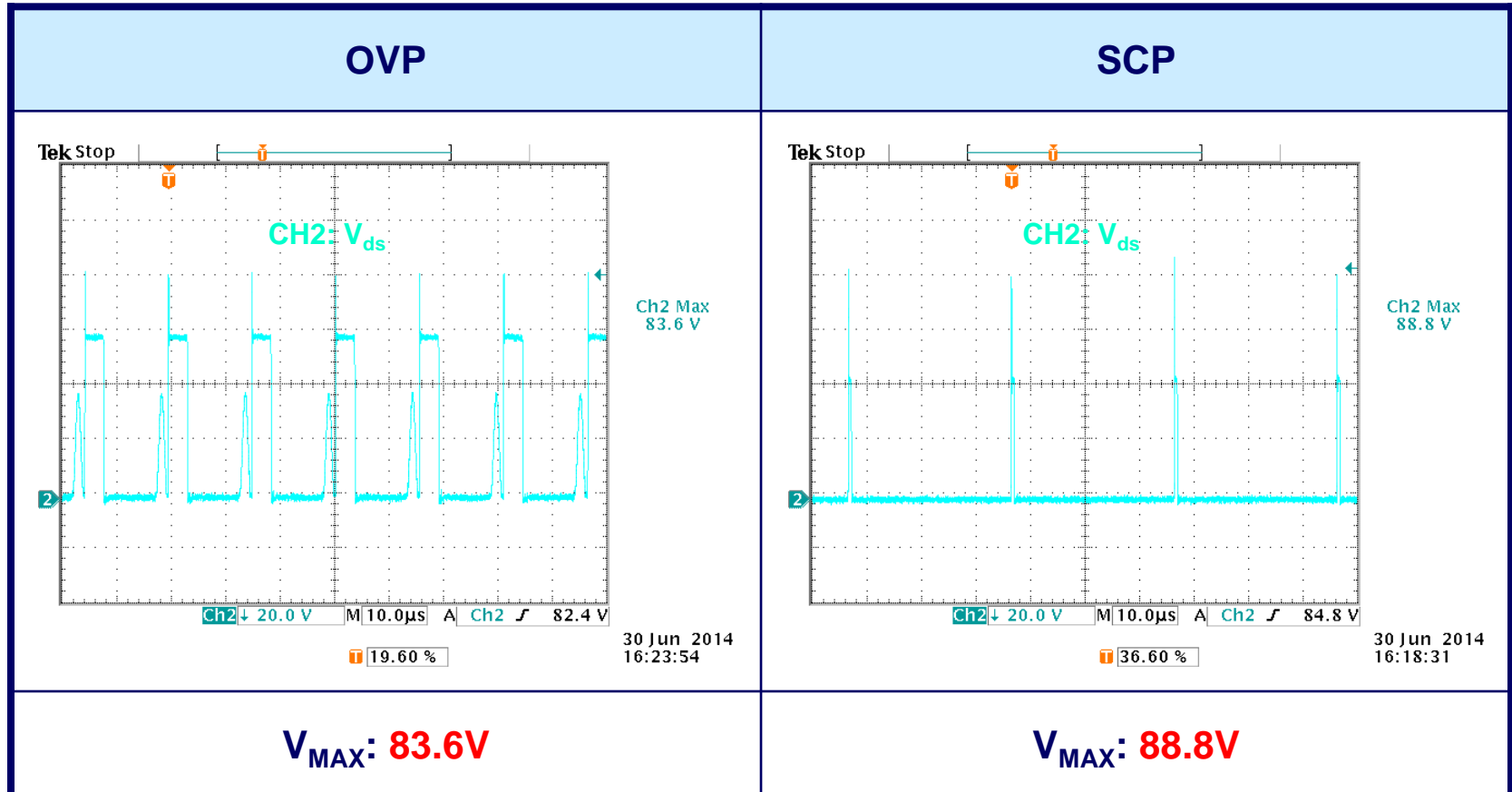

Comment: Pass

6.4 Protection

6.4.1 Short Circuit Protection (SCP)

Test Conditions:

- The unit was switched on with no load on the output. A short circuit was applied manually to the output at the end of the cable. The mains voltage was adopted to obtain the worst-case condition.
- A short circuit was applied to the output at the end of the cable before startup of the unit. The unit was switched on with a short circuit at the output. The mains voltage was adopted to obtain the worse-case condition.

Criteria To Pass:

- The unit shall be capable of withstanding a continuous (at least 2 hours) short-circuit at the output without damage or overstress of the unit under any input conditions.
- After removal of the short circuit, the unit shall recover automatically.
- The input power consumption must be **< 1.5W** at the full input range.

...Continued

V_{AC}/Hz	90/60	115/60	230/50	265/50
SCP	OK	OK	OK	OK
P_{IN}	1.392W	1.830W	282.29mW	364.4W

◆ Due to at low input voltage, SCP can't be triggered, OCP will protect the circuit instead. So the input power at low line is larger than high line.

Comment: Pass

Output short circuit at 90V_{AC}(Worst input)

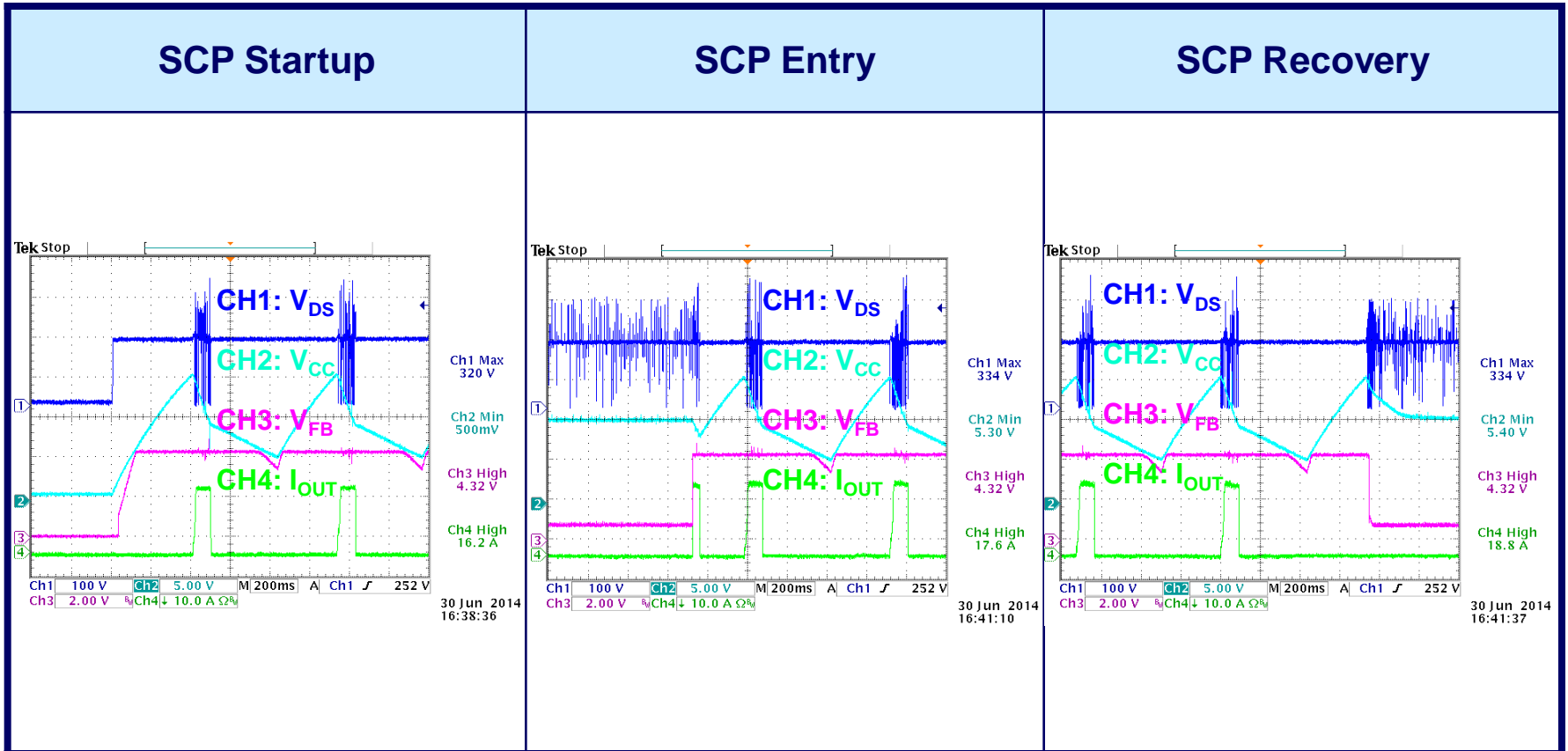

Comment: Pass

Output short circuit at 230V_{AC}(Typical input)

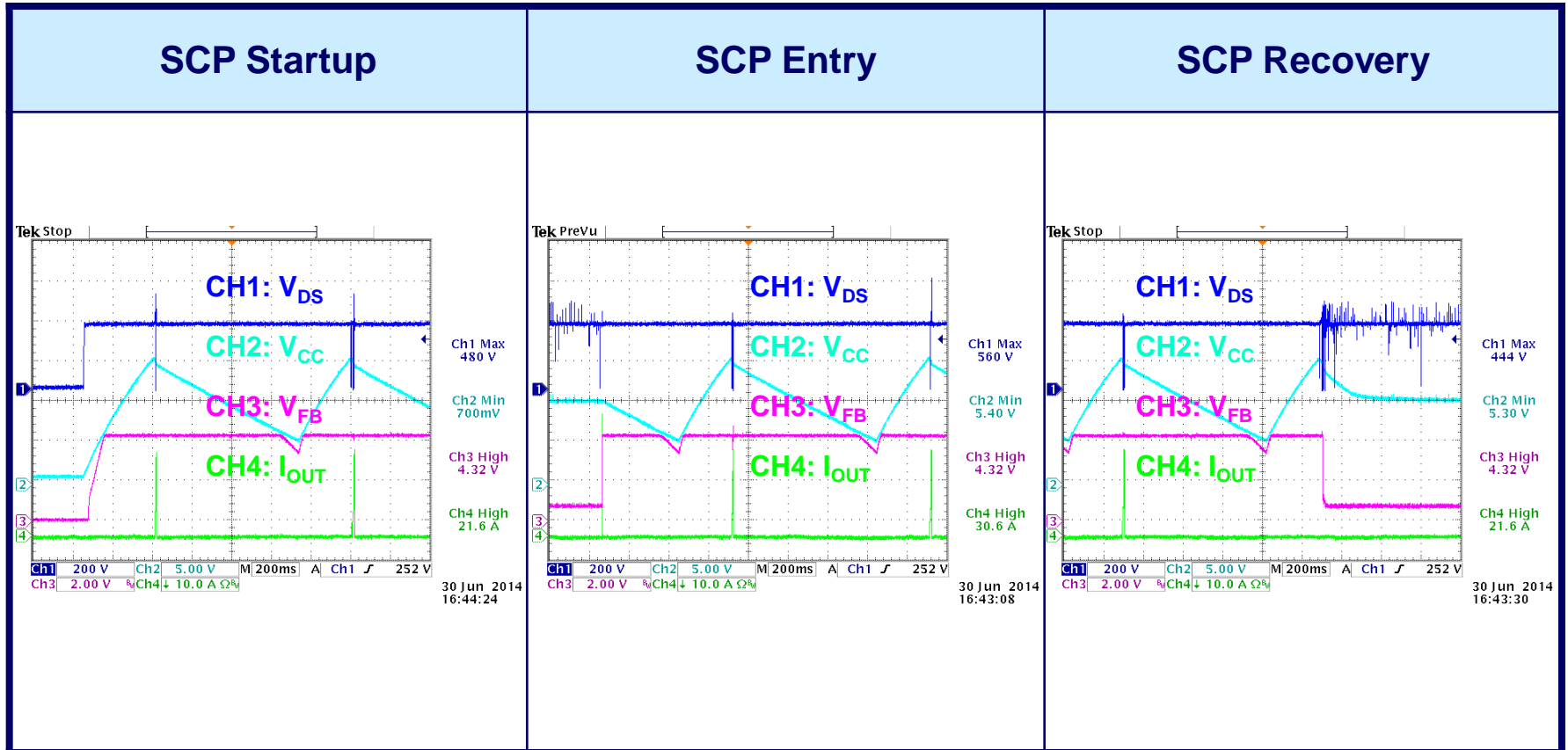

Comment: Pass

6.4.2 Over Current Protection (OCP)

Test Conditions:

- The load was increased from the maximum value to the an estimated over-current value in several steps.
- The test was repeated for different input voltages.

Criteria To Pass:

- The output power should be limited, just before the triggering of the over current protection, while the unit under any input conditions.

V_{AC}/Hz	90/60	115/60	230/50	265/50
OCP	5.68A	6.20A	5.69A	5.20A

Comment: Pass

...Continued

OCP at 230V_{AC}(Typical input)

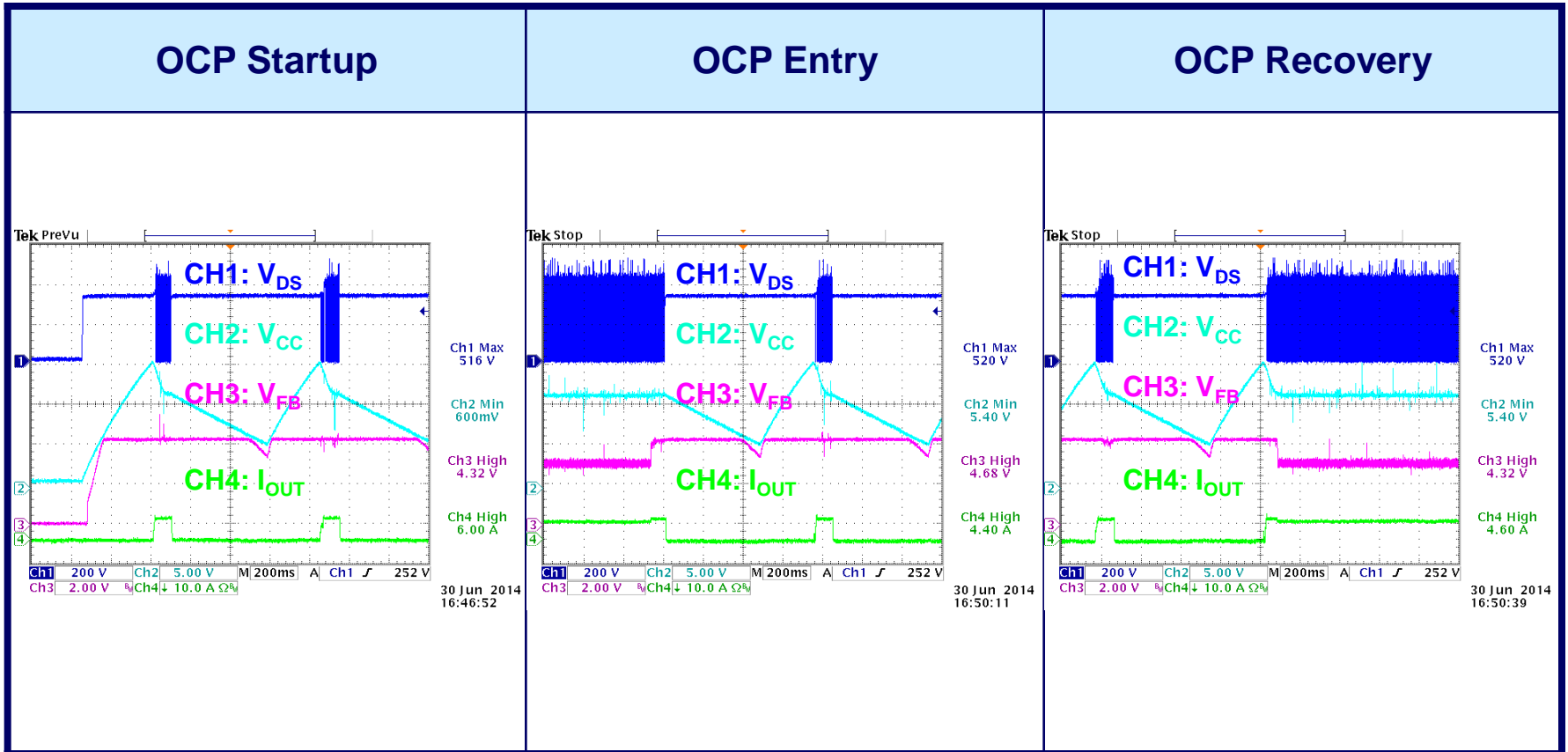

Comment: Pass

6.4.3 Output Over Voltage Protection (OVP)

Test Conditions:

- An output over voltage was created by applying a short circuit across the opto LED.
- An AC input voltage was selected so that the worst-case condition occurred.
- There was full load or no load on the output.

Criteria To Pass:

- The output voltage may not exceed **18V** or stabilize between **18V** and the rated voltage.
- At the moment OVP occurs, the primary side controller should be stay in latched mode or other protect mode.

Input (V_{AC}/Hz)	90/60	115/60	230/50	264/50
OVP Trip Point (V)	16.6	16.8	17.5	17.5

Comment: Pass

...Continued

OVP at 230V_{AC}

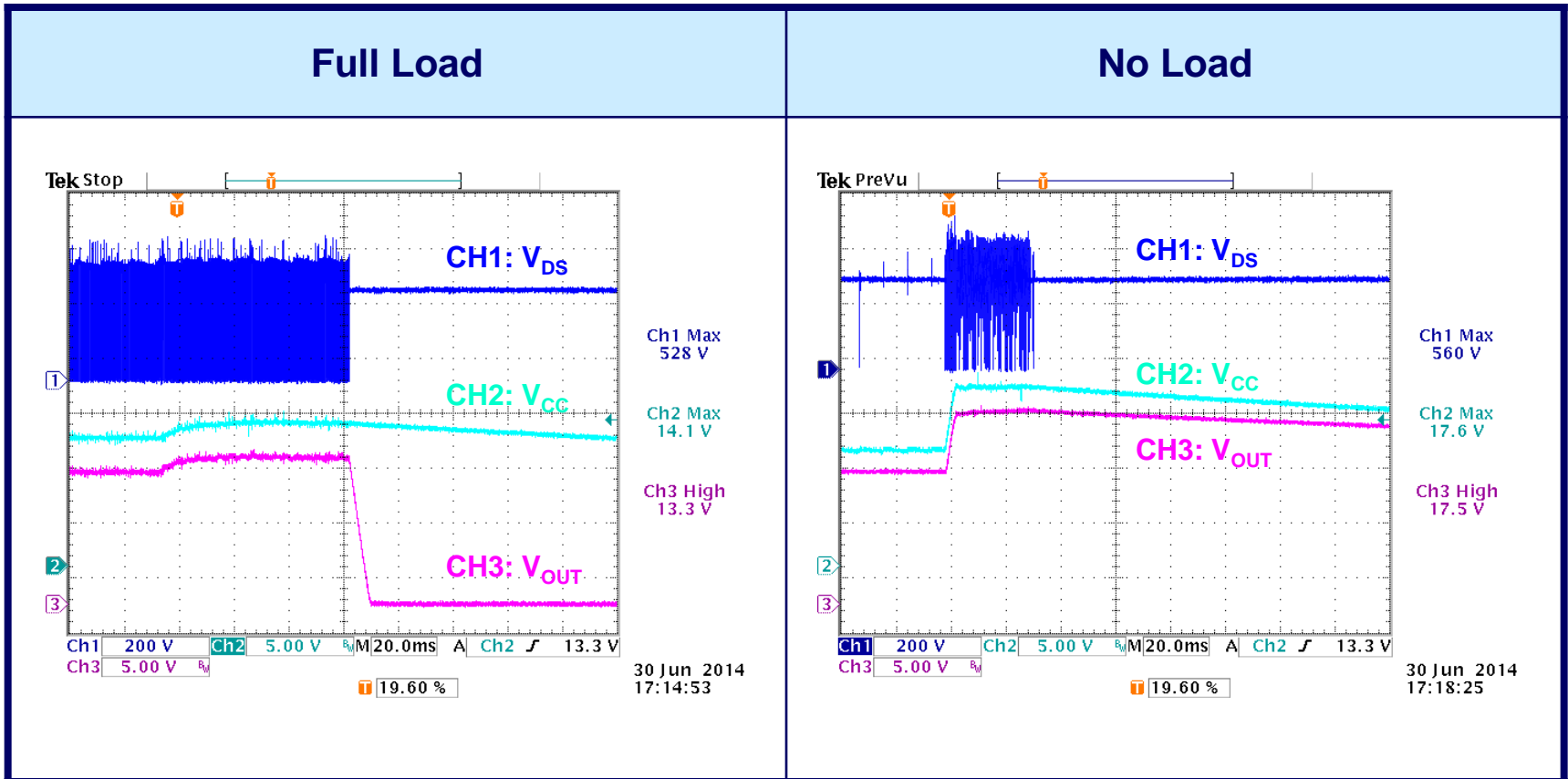

Comment: Pass

...Continued

OVP at 230V_{AC}

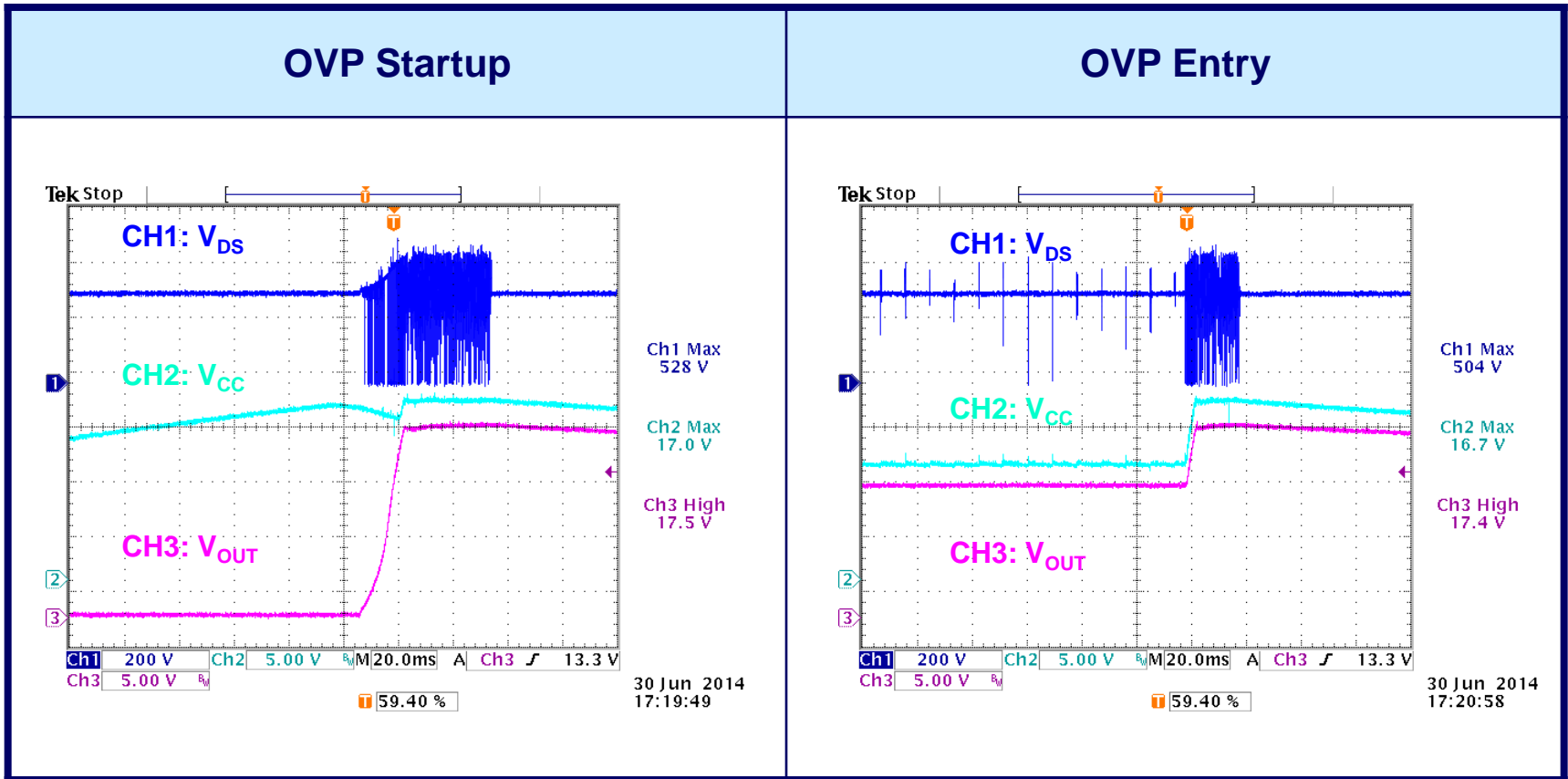

Comment: Pass

6.5 Output and Timing

6.5.1 Load Regulation (*Optional, only for multiple output*)

Test Conditions:

- The output voltage deviation was measured while the load current on the output was increased from **0A** to **5A**.
- The measurement was repeated for different input voltages.

Criteria To Pass:

- The output voltage deviation must remain within **1%**.

Comment: Pass

...Continued

Output Input	No Load	¼ Load	½ Load	¾ Load	Full Load
115V _{AC}	12.05V	12.04V	12.04V	12.02V	12.01V
230V _{AC}	12.05V	12.04V	12.03V	12.02V	12.01V

Comment: Pass

6.5.2 Output Ripple

Test Conditions:

- The measurement was made with an oscilloscope having a full bandwidth.
- The output was shunted at the end of the output ceramic disk capacitor or electrolytic capacitor.
- There was full load on the output.

Criteria To Pass:

- The ripple of the output must remain within the specified limits (**120mV_{p-p}**) at a maximum load current of **5A**.

V _{AC} /Hz	90/60	115/60	230/50	264/50
Ripple (mV)	1050	916	944	1010

Comment: Not Good

...Continued

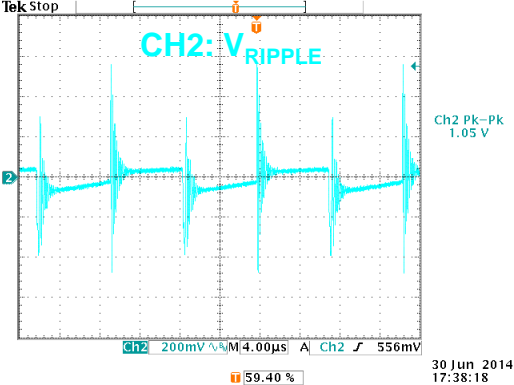
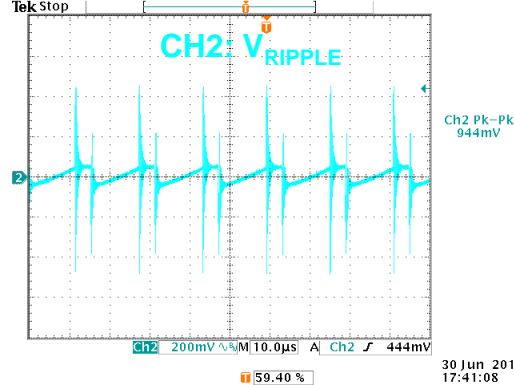
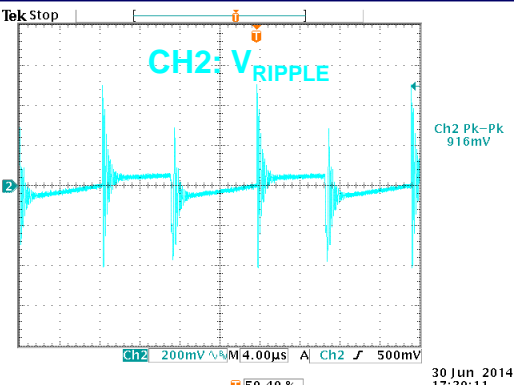
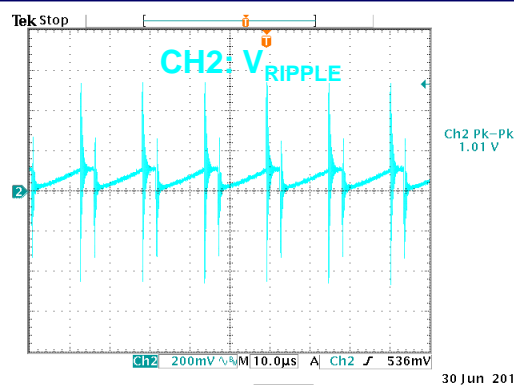
Input	Ripple waveform	Input	Ripple waveform
<p>90V_{AC}</p>	 <p>V_{P-P}: 1.05V</p>	<p>230V_{AC}</p>	 <p>V_{P-P}: 944mV</p>
<p>115V_{AC}</p>	 <p>V_{P-P}: 916mV</p>	<p>264V_{AC}</p>	 <p>V_{P-P}: 1.01V</p>

Comment: Not Good

6.5.3 Transient Response

Test Conditions:

- The load of the unit changed from **1A** to **4A** at a slew rate of **0.1A/us**.
- The frequency of change was set to give the best readability of the deviation and setting time.

Criteria To Pass:

- The output was not allowed to have an overshoot or undershoot beyond the specified limits (**+0.6V** to **-0.6V**) after a load change.

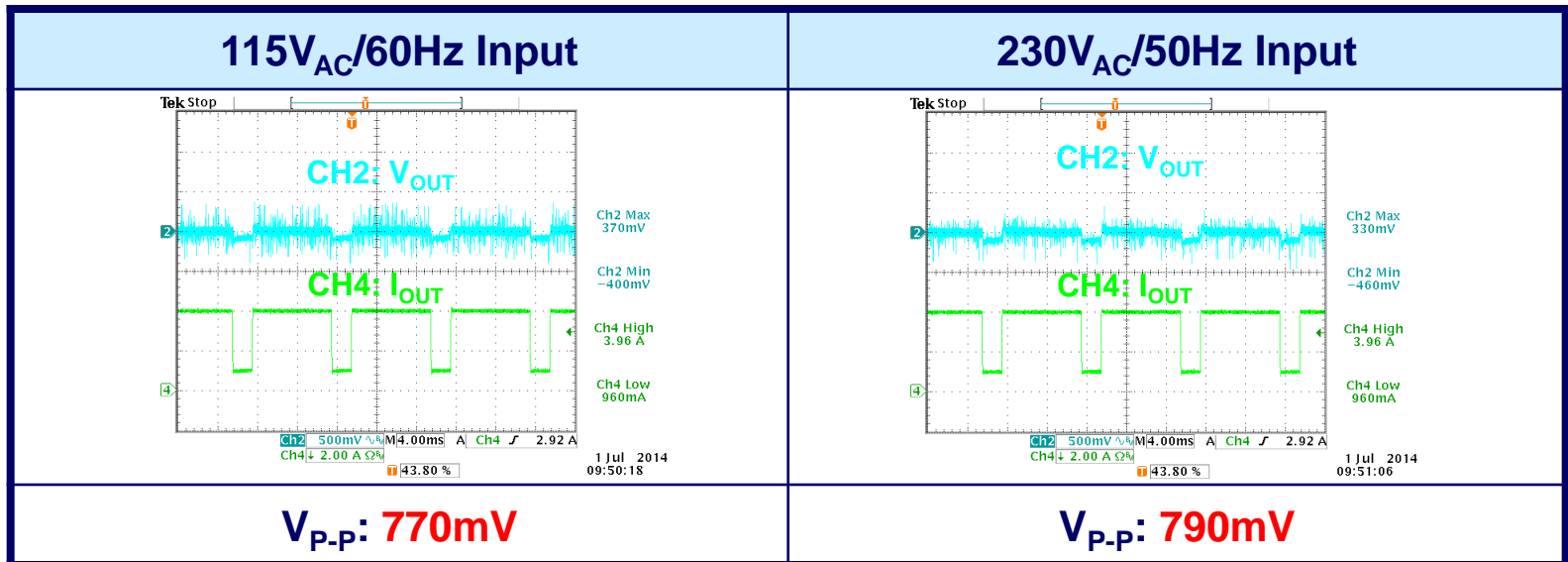

Comment: Pass

6.5.4 Turn-on Delay and Output Rise Time

Test Conditions:

- The electronic load was set to CC mode and $V_{ON} = 0V$.
- The electronic load was set to the maximum output current.

Criteria To Pass:

- Turn on delay: **1** Seconds maximum after the AC mains voltage was applied to the time when the output was within regulation.
- Output rise time: The output voltage shall rise from 10% of the maximum to the regulation limit within **25mS**. There must be a smooth and continuous ramp-up of the output voltage. No voltage with a negative polarity shall be present at the output during startup.

...Continued

90V_{AC}/60Hz Input

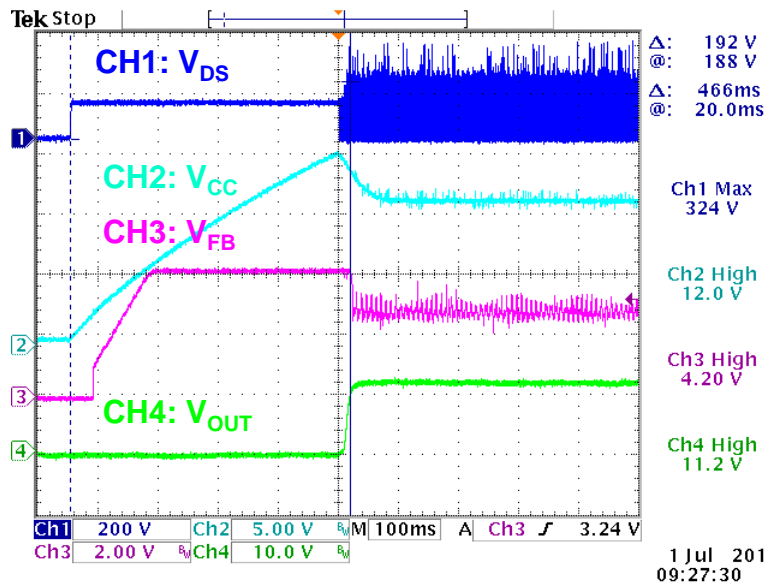

V_{OUT} Rise Time: **466ms**

264V_{AC}/50Hz Input

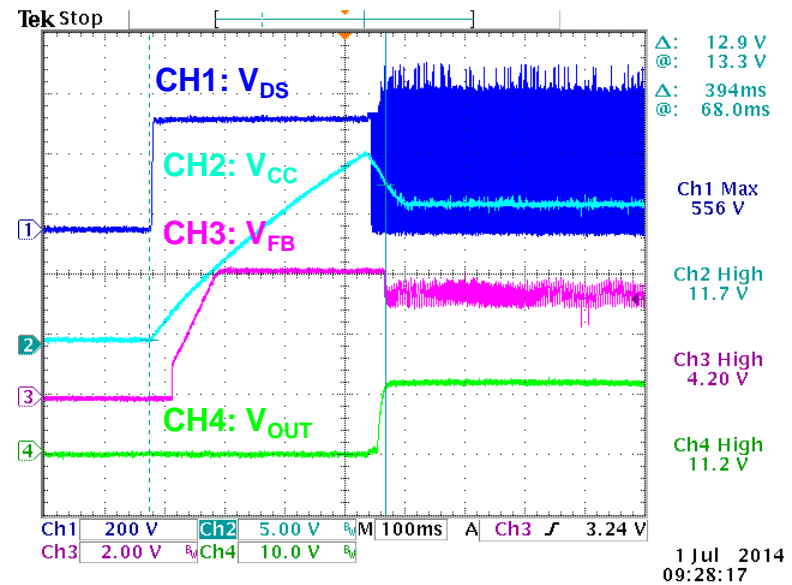

V_{OUT} Rise Time: **394ms**

...Continued

90V_{AC}/60Hz Input

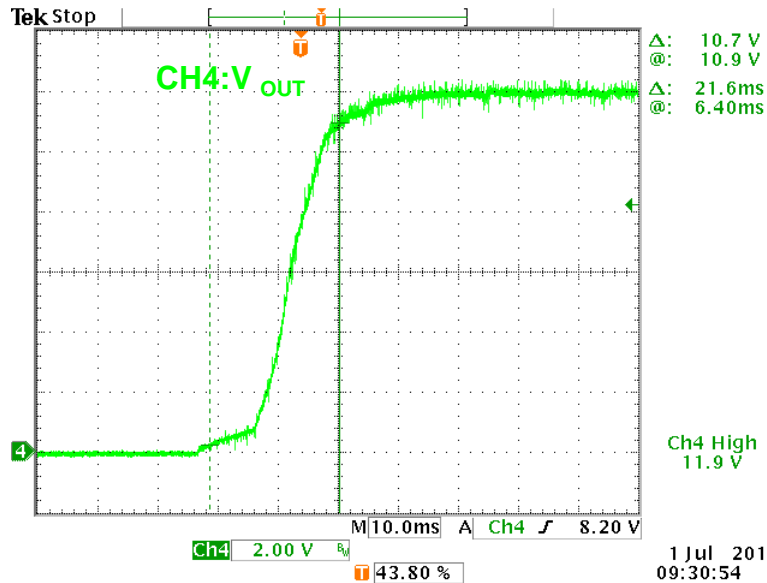

V_{OUT} Rise Time: **21.6ms**

265V_{AC}/50Hz Input

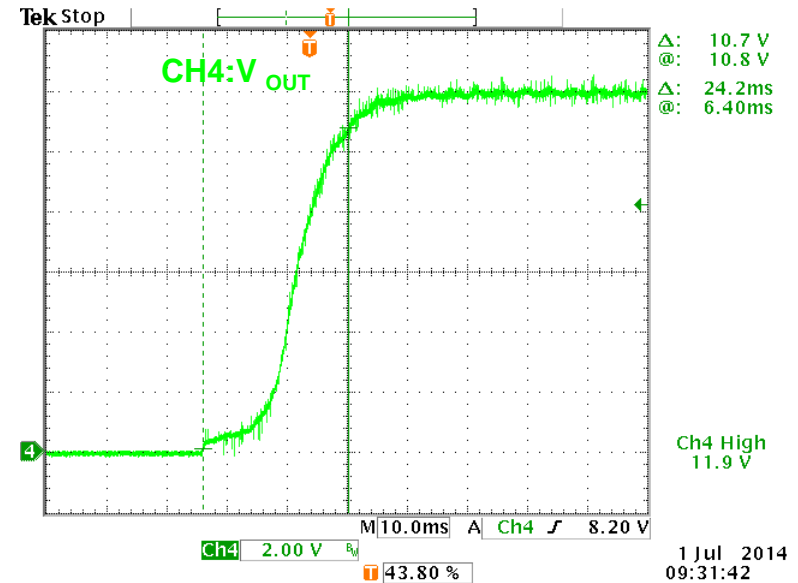

V_{OUT} Rise Time: **24.2ms**

Comment: Pass

6.6 Thermal

6.6.1 Parts Thermal

Test Conditions:

- The input voltage was set to minimum input.
- The electronic load was set to the maximum output current.
- The unit was covered, and the data was recorded until temperature stabilization was achieved. Ta=30°C

...Continued

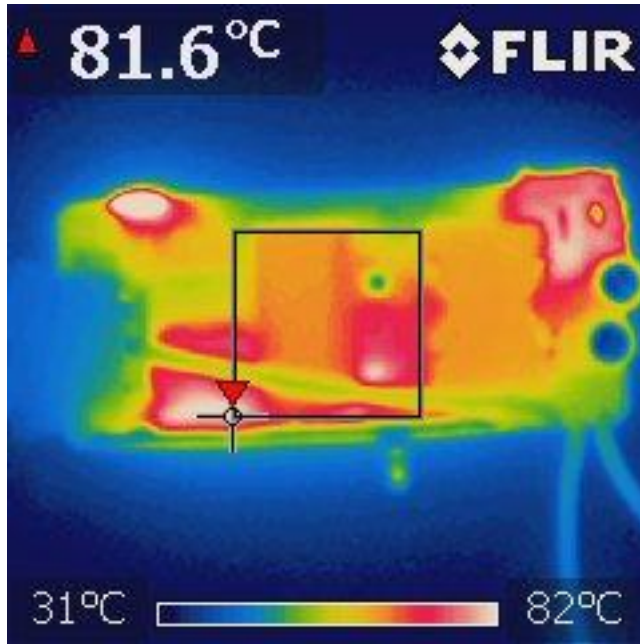

Top

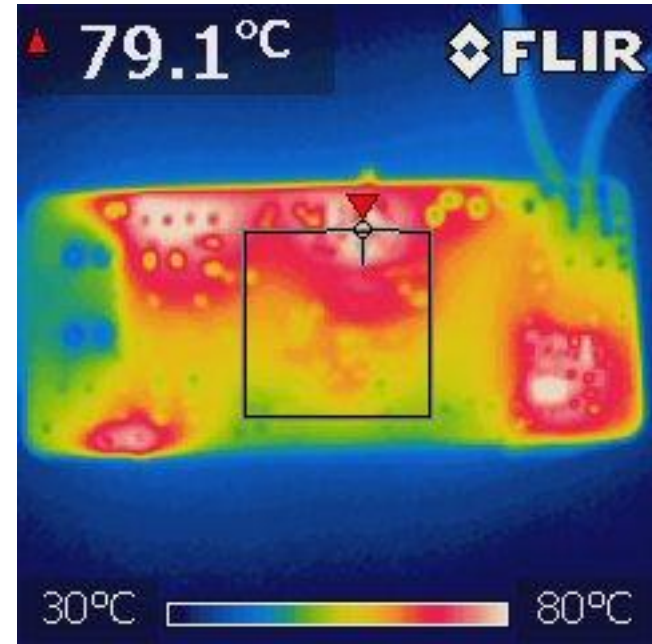

Bottom

Copper Thickness: 1 Oz

6.7 EMC and Safety

6.7.1 Conducted Emission

Test Conditions:

- The unit was subjected to 115V_{AC} or 230V_{AC} line and with maximum load.
- The test should include both L and N test.

Criteria To Pass:

- CISPR22 Class B with -6dB margin.

L(115V_{AC})

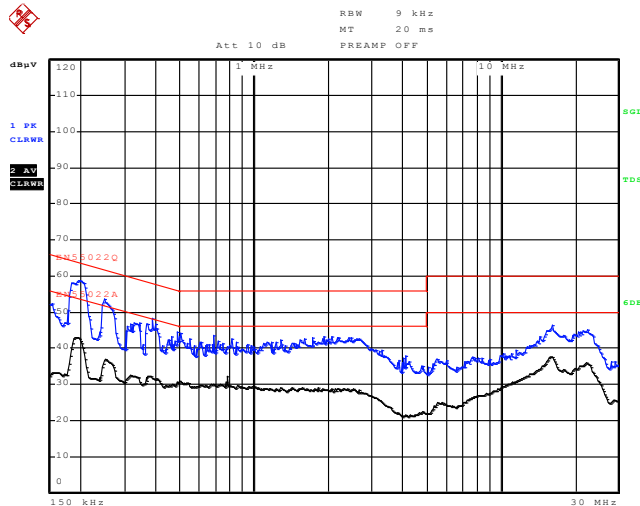

N(115V_{AC})

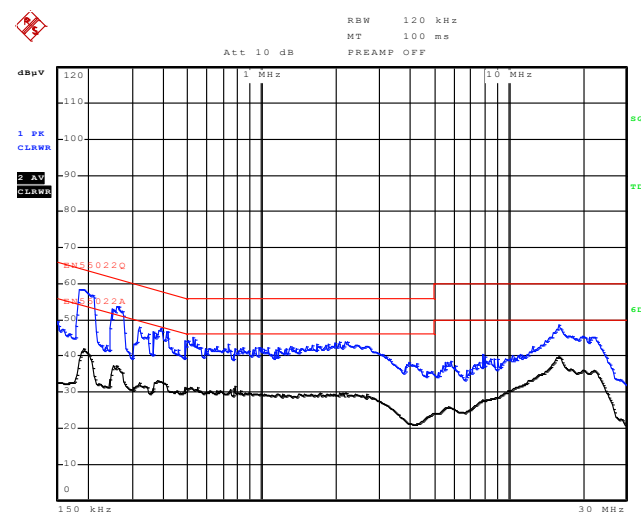

Comment: Pass

...Continued

L(230V_{AC})

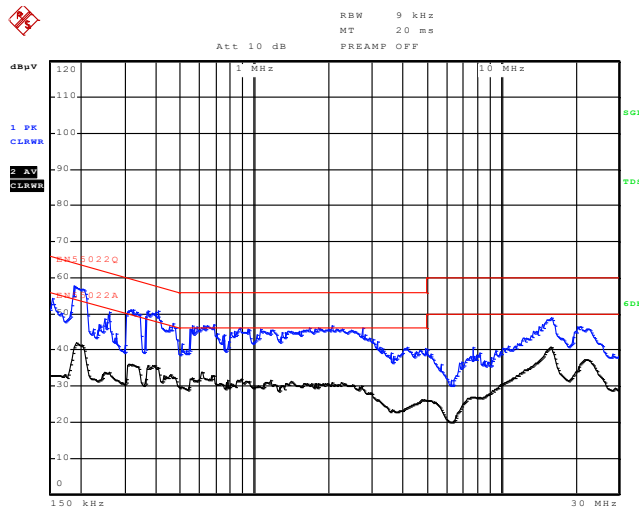

N(230V_{AC})

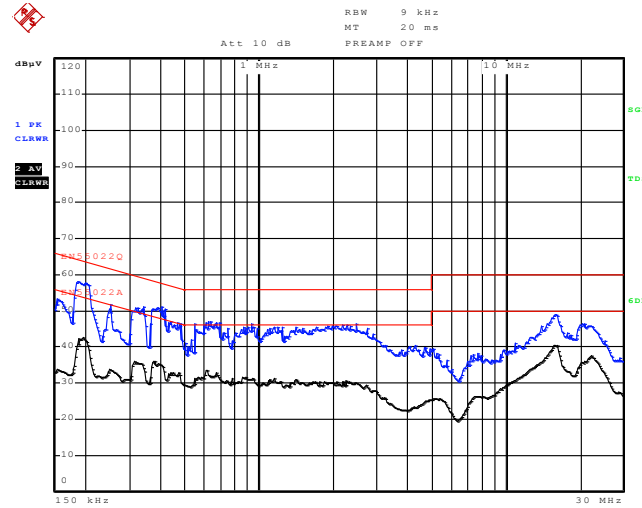

Comment: Pass